



smarter access for **everyone**



CONTROL + CONVENIENCE

CodeLocks is an innovative designer and distributor of locks, from robust and stylish mechanical locks to cutting-edge electronic and smart locks that use the latest technologies.

The locks can be used for a variety of applications, including doors, cabinets, lockers and enclosures. Access control is made easy, whether the application involves limiting building and room access or safeguarding confidential or hazardous materials.

Convenience is at the heart of CodeLocks products, which are designed to be user-friendly and give you complete control over who has access. The locks are cost-effective, easy to fit and program, can be retrofitted and do not require complex wiring or external power. Programming options include remote code generation, audit trail and code free options, along with a variety of other functions to suit your needs.



ACCESS CONTROL

Control + Convenience is at the heart of all our products.



SMART THINKING

We strive to create innovative solutions, not just locks.



DESIGN + DELIVER

High quality products, designed in-house and delivered globally.



FIRST CLASS SUPPORT

We provide hands on, expert sales, marketing and technical support.

Simple access control

Codelocks offer an extensive product range that allows the locks to service a wide variety of applications. From more traditional mechanical locks to cutting-edge electronic and smart products, locks can be newly installed or retrofitted, and many models can be re-programmed on the door, without the need for lock removal. Codelocks is constantly utilising and developing the latest technology to improve the functionality of its locks including remote code generation (NetCode®), which allows codes to be issued remotely, using a web portal or smartphone app. Smart locks enable even more convenient access control.

Digital lock innovators and experts

With over 30 years of security industry knowledge, Codelocks has the technical expertise to help you find the right access control solution that works for your application. With so much choice available, Codelocks is always on hand to help you select which access control solution works with your current systems, meets your budget and addresses the requirements of your buildings and people. Codelocks develop locks to meet the demands of changing environments, improving customer experience.

Passionate about quality

Founded in 1991, Codelocks is a global business with its company headquarters in the UK, based in Newbury, Berkshire. It also has offices in Europe, North America and Australia. Codelocks is committed to delivering the highest quality products to both commercial and domestic customers worldwide. The locks are designed in the UK with ease of use in mind, combining functionality with style. The Codelocks factories are accredited with the ISO 9001:2015 quality standard.

First class support

Codelocks has a dedicated technical team which is on hand to respond to any questions or queries. The team draws on its expert knowledge to offer advice and support both pre- and post-sales, whether that involves specifying the right product for a specific application or providing installation instructions. From one-off orders to large contracts, the high level of customer service remains the same. All prospective and existing customers have access to this source of specialist information and support. Codelocks also offers industry-specific training courses that can be tailored to meet varying customer needs.

Simple. Standalone. Smart.





CONNECT AND CONTROL.

The standalone smart lock; innovatively designed and manufactured by Codelocks to combine smart technology with traditional access control features.

MULTIPLE ACCESS OPTIONS

Codelocks Smart Locks provide flexibility and convenience by offering a range of access methods, allowing you to choose the most suitable for your application. Allow clients access via a simple code input, allocate and register a MIFARE® compatible card or send an invitation to their phone.

EASY OPERATION

Operate and manage locks directly via the keypad or via any Bluetooth compatible smartphone by downloading the C3 Smart App*. Program locks via your smartphone, generate and send codes for easy access, issue smart cards for alternative entry. Keep track on who, when and which locks were accessed by downloading and viewing the lock audit trail data. The lock does not require Wi-Fi connection for operation. This significantly increases its potential for use in areas where Wi-Fi is unavailable or intermittent, adding to the benefits of this innovative product line.

NETCODE® TECHNOLOGY

Generate and send time-sensitive codes to end users using the C3 Smart App* or Codelocks Connect Portal. Set codes for a specific start date and time, that will automatically expire after your set duration. Additional features include blocking NetCodes to control and restrict access.

CONTROLLED CODE FREE

Allow free access at set times of day by setting the lock into Code Free mode. Removes the hassle of unlocking doors for free access periods. Reduce the administration burden of manually putting locks into Code Free mode. Create up to 10 different Code Free periods that automatically enable only when scheduled. Code Free is used in many different situations - office hours only, cleaning staff, school environment (set Code Free periods for break times).

*The App is available on the Apple App Store for Apple devices or Google Play™ for Android™ devices. Apple, the Apple logo and iPhone are trademarks of Apple Inc., registered in the U.S. and other countries. App store is a service mark of Apple Inc. Android, Google Play and the Google Play logo are trademarks of Google Inc. The Codelocks Control + Convenience logo and NetCode® are registered trademarks of Codelocks Ltd., registered in the United Kingdom, United States and other countries and regions.



Managing and operating locks has never been easier.

Smart Locks offer advanced programming and access methods, as well as simple retrofit opportunities for easy upgrades.

SMART LOCK FEATURES

- Manage and operate locks via smartphone
- Keyless entry - no lost keys
- Two year guarantee*
- 12 button back-lit keypad
- NetCode® generation technology
- Set up to 10 Code Free access periods
- Suspend and restore any or all clients
- Mortice Latch, Mortice Lock and Panic Kit available
- Keypad indicates locked / unlocked status
- Tamper time out and low battery warning
- Personal wireless connectivity for management
- Simple upgrade from electronic range using same fixings
- Auxiliary connections enabling four modes of operation



CODE.

100 Client User Codes



CARD.

150 Client Smart Cards



PHONE.

100 Phone Clients

LOCK MODELS

Mortice Latch

CL4510 + CL5510

Medium duty tubular mortice latch retracts via the outside knob after a valid code input. When the door closes, the spring latch will lock the door.

Mortice Lock

CL4520 + CL5520

Euro profile mortice sash lock with deadbolt and latchbolt. With the deadbolt thrown it denies access to code users. Supplied with Euro profile cylinders and three keys.

Panic Access Kit

CL5510 Only

Front plate only. Install with new or existing panic equipment. The follower on the panic equipment must return to square to align with follower on the lock.

Two Mortice Latch Sizes Available:

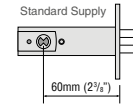

Requires
25mm x 82mm
(1" x 3 1/4") hole

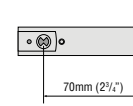

Requires
25mm x 92mm
(1" x 3 5/8") hole

AUXILIARY CONNECTIONS

Remote Release

REM1 is intended for push-button release where the lock will open for the normal set time. REM2 is intended for use where the lock needs to be released for a longer period. When a switch or relay connected to REM2 is closed, the lock will open for a period of 30 minutes after which the lock will revert to normal operation.

Sensor Mode

Allows two dry contact switches or sensors (door status and latch monitoring) to be connected. Trigger entry will be added to the audit trail.

Sensor + Alert

A hybrid mode combining the support for a single dry contact switch or sensor (as per Sensor Mode) and an output. The output can be connected to any compatible device, such as CCTV, with an input that supports the detection of a falling (changing) voltage.

Unlock + Lock Down

Support the connection of two dry contact switches. Connected to REM1, the switch will unlock the lock for the period set by the standard re-lock delay. Connected to REM2, the switch would trigger the Lock Down Mode of the lock, disabling all codes aside from the Master and Sub-Master codes.

STANDARDS

Codelocks Smart Fire Kits can be fitted to latch locks for 30 or 60 minute fire doors. Tested in accordance with: BS EN 1634-1:2008

PRODUCT DIMENSIONS

CL4510

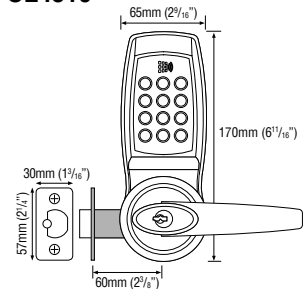

CL4520

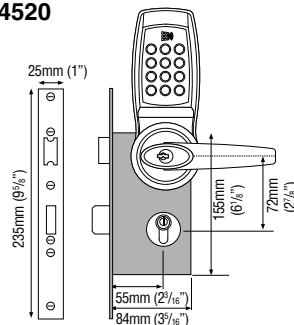

CL5510

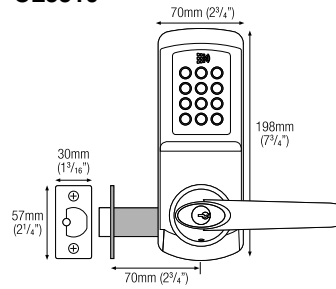

CL5520

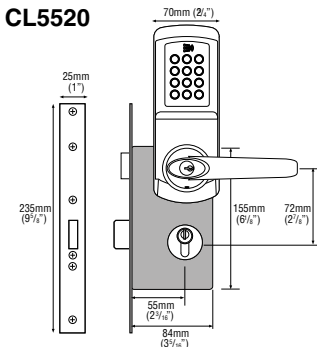



1 2 3
4 5 6
7 8 9
* 0 #

CODELOCKS.COM

Smart, streamlined access control for serviced apartments.

“Thanks to Codelocks’ NetCode® technology, the locks offer ultimate flexibility, giving us new levels of control without compromising on security. We have a few long term guests, so rather than provide them with a code, we issue them a smart card which makes access more convenient.”

- Lifestyle Serviced Apartments



mechanical

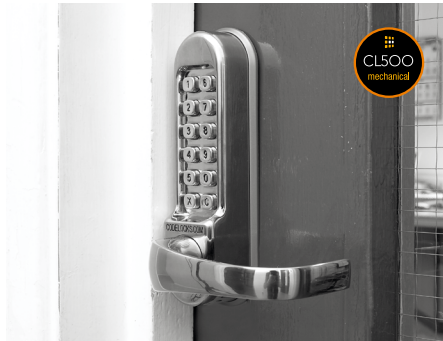

MECHANICAL RANGE

Simple and convenient access control solutions.

Easy to install, Codelocks' mechanical range of locks offer coded access suitable for a variety of applications for both internal or external environments. Where a single, easily changed code is required, mechanical locks are an ideal access control solution.

- Light, medium and heavy duty models
- Suitable for internal and external use
- Various finish and handle options
- Easy to install and operate
- Locks will suit left or right hand hung doors
- Code free access functionality



Marine

by Codelocks

Tech
Spec



CL200

CL400

CL500

CL600

KEY FEATURES

- Salt spray tested 1000 hours*
- Resistant against moisture/salt spray*
- Suitable for internal and external applications
- Limited lifetime guarantee**
- Specially enhanced, durable black finish suited to harsh environments



Marine

by Codelocks

The Marine by Codelocks range of mechanical locks feature a specially enhanced, salt spray tested* black marine grade finish to better withstand harsh outdoor environments and coastal applications. The range includes selected locks from the CL200, CL400, CL500 and CL600 mechanical ranges, offering the benefits of key override options, lever handles and ball knob handles. They're the same tough, convenient, easy-to-use locks with a finish to match.

Reliable and durable, these locks are ideal for external applications; outbuildings, construction sites, marinas and homes by the water. Providing convenient, easy access, the sleek black finish adds sophistication to any application.

UNIVERSAL SPECIFICATIONS

FEATURE	DESCRIPTION
Mortice Latch	Medium duty latch with 'anti-shim' plunger
Mortice Lock	Euro profile mortice sash with deadbolt and latchbolt
Material	Zinc Alloy
Finish Colour	Black marine grade
Non Handed	Locks will fit doors hung on the left or right
Door Thickness	35mm - 60mm (1 ³ / ₈ " - 2 ³ / ₈ ")
Code Storage	Single Code
Suitable For	Internal and external use
Standards	Codelocks Fire Kits can be fitted to latch locks for 30 or 60 minute fire doors. Tested in accordance with: BS EN 1634-1

*Tested in-house by Codelocks Ltd.

For detailed technical specifications, see corresponding lock model's brochure page.



MINI MECH LOCK



The CL50 is an easy-to-fit light duty mechanical push button lock with a tubular latch.

The CL50 is a mini mechanical lock, its compact size makes it suitable for low traffic, internal applications. The keyless lock provides immediate access with a 4-6 digit code length, providing 500+ code combinations. The lock comes in a silver grey finish and installation is simple; drill one hole for the latch, one for the spindle and two holes for the fixing bolts. Control access to individual offices, store cupboards, school arts and IT storage. The CL50 is extremely versatile.



Easy to install



Suitable for wooden doors



Limited lifetime guarantee*

511

Total code combinations

FEATURES

- Mini mechanical push button lock
- 60mm backset latch as standard
- 50mm and 70mm backset latches available
- Easy action internal lever
- Hold open function allowing Code Free access
- 4-6 digit code length
- Suitable for low traffic applications
- Flat spring loaded spindle
- Silver Grey finish
- Non handed - locks will suit right or left hand hung doors
- Light duty latch bolt with 'anti-shim' plunger
- Neoprene seals included

LOCK FUNCTIONS



Hold Open Function

As standard, supplied with a hold open function enabled, allowing free entry when required, without having to use an access code. The function can be disabled during installation requiring code input to retract the latch and open the door.

Code Change Method

Requires removal of the lock from the door. The code can then be changed by simply repositioning the tumblers in the code chamber. Locks are supplied with a random code commencing with the 'C' (Clear) button.

Code Combinations

Digits may only be used ONCE in a code. For example, 1212 is not possible. A code, or combination, can be entered in any order; e.g. 1234 can be entered as 4321, or 1342 - whichever sequence is most convenient to remember.

TECHNICAL SPECIFICATIONS

FEATURE	DESCRIPTION
Spindle Type	Flat spring loaded spindle
Material	Zinc Alloy
Finish	Silver Grey
Non Handed	Locks will fit doors hung on the left or right
Door Thickness	35mm - 60mm (1 ³ / ₈ " - 2 ³ / ₈ ")
Code Storage	Single Code
Buttons	10 stainless steel buttons
Fitting Options	Vertical only
Suitable For	Low traffic applications - internal use

LATCH OPTIONS

The CL50 features a light duty mortise latch with 'anti-shim' plunger, supplied at a standard size of 60mm. Alternative 50mm or 70mm latches are available.

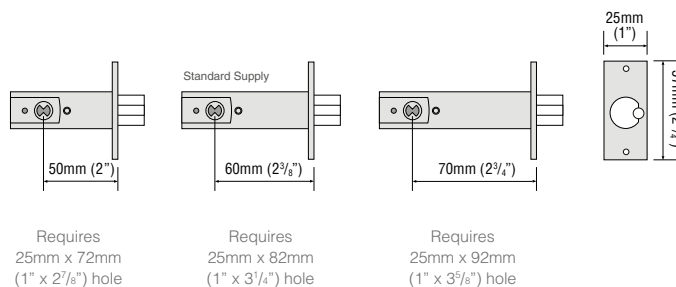

PRODUCT DIMENSIONS

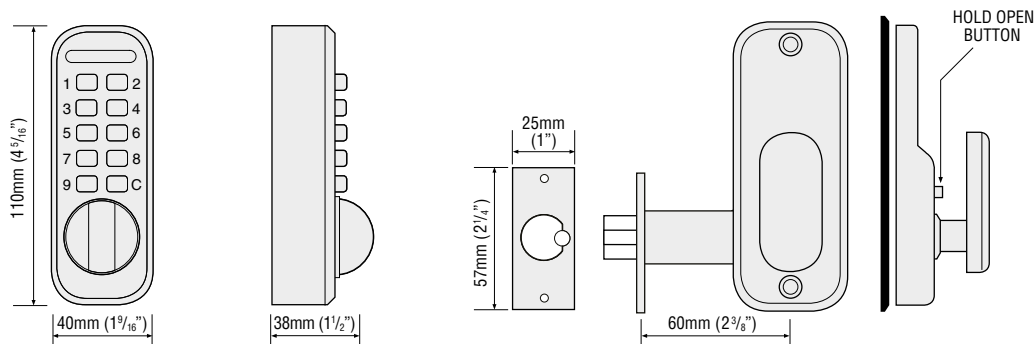

SIMPLE CONVENIENT CONTROL



Suitable for a variety of light duty entry control applications in commercial and residential premises.

The CL100 range features four different models to suit a wide range of applications, including the CL160 QuickCode allowing on the door code changes. The locks come in two finishes and are excellent value for money. Installation is simple; just drill one hole for the spindle, two holes for the fixing bolts and one extra if a mortice latch is required. Ideal for light duty use for office doors, storage rooms, sheds, internal doors and cupboards at home.



Easy to install



Suitable for wooden doors



Limited lifetime guarantee*

1,023+

Total code combinations

FEATURES

- Four models available
- Choice of three latches - 50, 60, 70mm
- Suitable for internal and external use
- Dual backplate allows option of hold/non-hold open
- Tumbler alignment for easy code change
- Suitable for low traffic applications
- Selected models available in silver grey or polished brass finish
- Neoprene seals included
- Codelocks Fire Kit Packs can be fitted to latch locks for 30 or 60 minute fire doors. Tested in accordance with BS EN 1634-1

LOCK MODELS



CL100

Surface Deadbolt

Bolt slides on inside of door, to lock or unlock. Bolt is moved manually by outside knob after code input and freely by inside knob at all times.



CL155

Mortice Latch

Light duty tubular mortice latch retracts by turning inside lever freely, or the outside knob after code input. Features hold open function.



CL160

QuickCode

Light duty tubular mortice latch. Features QuickCode allowing codes to be changed on the door rather than having to remove the lock.



CL190

Back to Back Option (BB)

Light duty tubular mortice latch. Two coded plates for installation on both sides of the door. Provides coded access in both directions.

Three Mortice Latch Sizes Available:

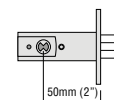

Requires
25mm x 72mm
(1" x 2⁷/₈") hole

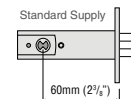

Requires
25mm x 82mm
(1" x 3¹/₄") hole

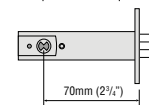

Requires
25mm x 92mm
(1" x 3⁵/₈") hole

PRODUCT DIMENSIONS

CL100 CL155 CL190

8,191 non sequential codes available

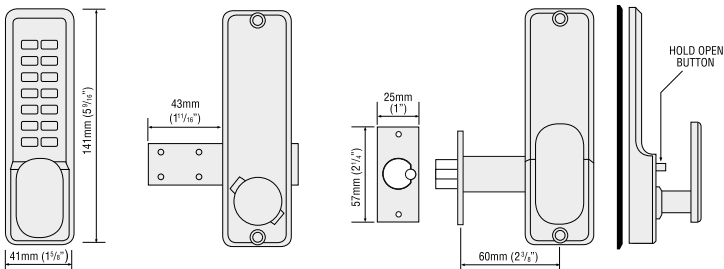

CL160

1,023 non sequential codes available

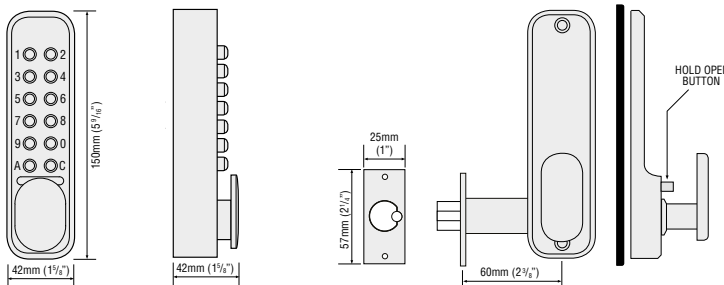

TECHNICAL SPECIFICATIONS

Hold Open Function

Latch models are supplied with a hold open function enabled allowing free entry when required, without having to use a code. The function can be disabled during installation requiring code input to open the door.

Code Change Method

CL100, CL155 and CL190 models require removal of the lock from the door. The code can be changed by repositioning the tumblers in the code chamber. The CL160 features QuickCode, allowing on the door code changes.

FEATURE	DESCRIPTION
Spindle Type	Flat spring loaded spindle
Mortice Latch	Light duty latch with 'anti-shim' plunger
Material	Zinc Alloy
Finish	Silver Grey & Polished Brass
Non Handed	Locks will fit doors hung on the left or right
Door Thickness	35mm - 60mm (1 ³ / ₈ " - 2 ³ / ₈ ")
Codes	Non sequential
Code Storage	Single Code
Code Type	Non sequential
Buttons	Stainless steel buttons
Fitting Options	Vertical only
Suitable For	Low traffic applications - internal and external use

** Excludes CL160.

POPULAR MECHANICAL LOCK



Premium range of light duty mechanical locks. Multiple options available suitable for a wide range of applications.

Locks in the CL200 range allow various ways to manage entry - by code, key or hold open operations. The key can be used to retract the latch without the need for the code. On request, multiple locks can be supplied coded or keyed alike. Back to Back versions are also available, suitable for environments where a code is required on both sides of the door.



Easy to install



Key override options



Limited lifetime guarantee*

8,191

Total code combinations

FEATURES

- Multiple models and options available
- PVD low maintenance finish
- Choice of three latches - 50, 60, 70mm
- Key override option available across all models
- Suitable for internal and external use
- Dual backplate allows option of hold/non-hold open
- Tumbler alignment for easy code change
- Selected models available in stainless steel or polished brass finish
- Suitable for wooden doors between 35mm - 60mm thick
- Neoprene seals included
- Codelocks Fire Kit Packs can be fitted to latch locks for 30 or 60 minute fire doors. Tested in accordance with BS EN 1634-1

LOCK MODELS



CL200

Surface Deadbolt

Bolt slides on inside of door, to lock or unlock. Bolt is moved manually by outside knob after code input and freely by inside knob at all times.



CL210

Mortise Deadbolt

Bolt is moved manually by outside knob after code input and freely by inside knob at all times. Bolt extends 25mm (1") beyond door edge when locked.



CL255

Mortise Latch

Light duty tubular mortise latch retracts by turning inside lever freely, or the outside knob after code input. Features hold open function.



CL290

Back to Back Option (BB)

Light duty tubular mortise latch. Two coded plates for installation on both sides of the door. Provides coded access in both directions.

Three Mortise Latch Sizes Available:

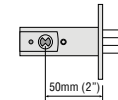

Requires 25mm x 72mm (1" x 2 7/8") hole

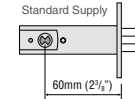

Requires 25mm x 82mm (1" x 3 1/4") hole

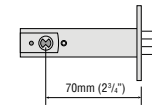

Requires 25mm x 92mm (1" x 3 5/8") hole

ADDITIONAL FEATURES

Hold Open Function

Latch models are supplied with a hold open function enabled allowing free entry when required, without having to use a code. The function can be disabled during installation requiring code input to open the door.

Key Override

Key override is available to order on any model within the CL200 range. Locks can be keyed alike on request.

Marine Grade

Selected CL200 models are also available in a black, marine grade finish. Salt spray test up to 1000 hours*

*Tested in-house by Codelocks



TECHNICAL SPECIFICATIONS

Code Change Method

Requires removal of the lock from the door. The code can be changed by repositioning the tumblers in the code chamber. Locks are supplied with a random code commencing with the 'C' clear button.

FEATURE	DESCRIPTION
Spindle Type	Flat spring loaded spindle
Mortise Latch	Light duty latch with 'anti-shim' plunger
Material	Zinc Alloy
Finish	PVD (Physical Vapour Deposition), low maintenance
Finish Colour	Stainless Steel (All) & Polished Brass (Excludes CL200)
Non Handed	Locks will fit doors hung on the left or right
Door Thickness	35mm - 60mm (1 3/8" - 2 3/8")
Codes	8,191 non sequential code combinations available
Code Storage	Single Code
Buttons	14 stainless steel buttons
Key Override	Available to order with any model
Keyed Alike	Locks can be supplied keyed alike on request
Fitting Options	Vertical only
Suitable For	Internal and external use
Standards	Codelocks Fire Kits can be fitted to latch locks for 30 or 60 minute fire doors. Tested in accordance with: BS EN 1634-1

PRODUCT DIMENSIONS

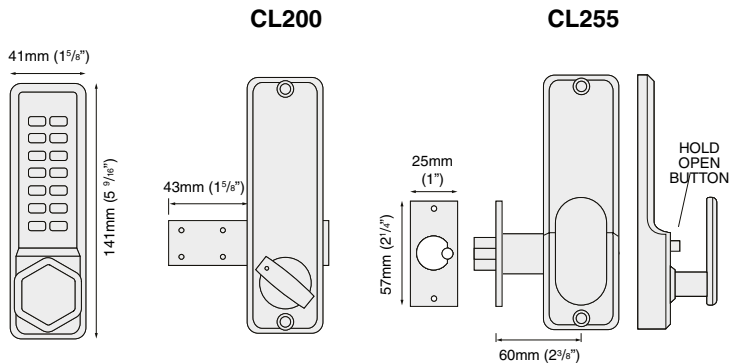



LEVER HANDLE MECHANICAL



Medium duty mechanical locks with full size lever handles. Ideal for use in environments where a knob operated lock would be unsuitable.

The CL400 range of locks offer a variety of functions, allowing users flexibility on how to manage entry - by key, code or code free access. Throwing the deadbolt on the mortice lock models will lock out code users when appropriate. Safety features ensure that the inside lever handle will retract the deadbolt so avoiding accidentally locking a person inside the room. Front and back plates can be purchased for use with existing locks.



Easy to install



Suitable for wooden doors



Limited lifetime guarantee*

8,191

Total code combinations

FEATURES

- Full size lever handles with return to door
- PVD low maintenance finish
- Code Free access options
- Suitable for internal and external use
- Mortice latch and mortice lock models available
- Tumbler alignment for easy code change
- Selected models available in stainless steel or polished brass finish
- Neoprene seals included
- Codelocks Fire Kit Packs can be fitted to latch locks for 30 or 60 minute fire doors. Tested in accordance with BS EN 1634-1

LOCK MODELS



Front and Back Plates

Front and back plates only. Use with existing mortice latch or lock. Existing lock must have a fixing hole 22mm (7/8") below follower (spindle).



Mortice Latch

Medium duty tubular mortice latch with 'anti-shim' plunger. Latch retracts by turning inside handle freely, or the outside handle after code input.



Back to Back Option (BB)

Medium duty tubular mortice latch. Two coded plates for installation on both sides of the door. Provides coded access in both directions.

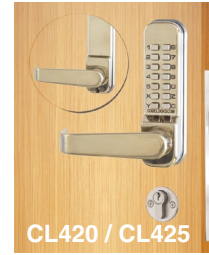

Mortice Lock

Euro profile mortice sash lock with deadbolt and latchbolt. With the deadbolt thrown it denies access to code users. Supplied with Euro profile cylinders and three keys.

Two Mortice Latch Sizes Available:

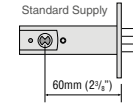

Requires 25mm x 82mm (1" x 3 1/4") hole

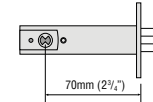

Requires 25mm x 92mm (1" x 3 5/8") hole

ADDITIONAL FEATURES

Code Free Access

The CL405, CL415 and CL425 models provide a Code Free option. These models feature a black dot on the 'Y' button. When the 'Y' button is pressed along with a correct code input, the lever will retract the latch freely until disabled.

Split Follower

The CL420 and CL425 Mortice Lock models utilise a split follower as a safety feature. This enables the inside lever to retract the deadbolt and latchbolt, after the deadbolt has been thrown, to prevent an accidental lock in.

Marine Grade

Selected CL400 models are also available in a black, marine grade finish. Salt spray test up to 1000 hours*

*Tested in-house by Codelocks



TECHNICAL SPECIFICATIONS

Code Change Method

Requires removal of the lock from the door. The code can be changed by repositioning the coloured tumblers in the code chamber. Locks are supplied with a random code commencing with the 'C' clear button.

FEATURE	DESCRIPTION
Spindle Type	Two part 8mm (5/16") spring loaded spindle
Mortice Latch	Medium duty latch with 'anti-shim' plunger
Mortice Lock	Euro profile mortice sash with deadbolt and latchbolt
Material	Zinc Alloy
Finish	PVD (Physical Vapour Deposition), low maintenance
Finish Colour	Stainless Steel & Polished Brass
Non Handed	Locks will fit doors hung on the left or right
Door Thickness	35mm - 60mm (1 3/8" - 2 3/8")
Codes	8,191 non sequential code combinations available
Code Storage	Single Code
Buttons	14 stainless steel buttons
Fitting Options	Vertical only
Suitable For	Internal and external use
Standards	Codelocks Fire Kits can be fitted to latch locks for 30 or 60 minute fire doors. Tested in accordance with: BS EN 1634-1

PRODUCT DIMENSIONS

CL410 CL415

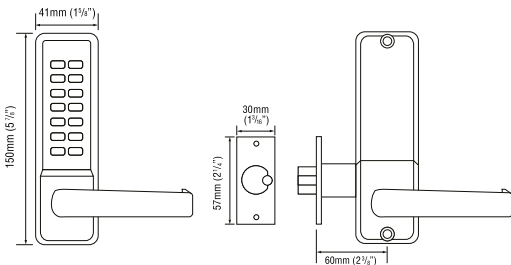

CL420 CL425

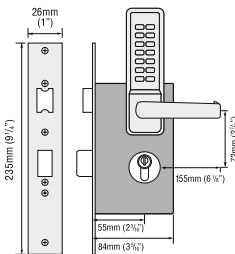



NARROW STILE CODELOCK



Narrow stile mechanical Codelock suitable for aluminium doors. An affordable alternative to electronic keypads, electrical strikes, magnetic locks and other systems used on aluminium framed doors.

The narrow stile lock is medium duty, ideal for new or retrofit applications. Designed to be retrofitted to Adams Rite or similar ANSI round cylinder mortice deadlatches. Deadlatches are also available from Codelocks (see reverse for further detail). The locks have a variety of access control functions, allowing the user flexibility on how to manage entry - by key, code or code free entry.



Easy to
install



Suitable for
aluminium doors



Limited lifetime
guarantee*

8,191

Total code
combinations

FEATURES

- Full size lever handles with return to door
- Ball shape knob available
- Stubby lever handle available
- Code Free access options
- Suitable for internal and external aluminium doors
- Two models available
- PVD low maintenance finish
- Stainless steel finish
- Neoprene seals included
- Field handed keypad - will fit doors hung on the left or right

LOCK MODELS



CL460 / CL465

Front and Back Plates

Narrow stile Codelock complete with cams, threaded cylinder and lever handles.



CL470 / CL475

Front and Back Plates

Narrow stile Codelock complete with cams, Euro profile cylinder and lever handles.

ADDITIONAL FEATURES

Latch Options

25mm (1") and 29mm (1 1/8") backset latches available on request (sold separately).

Deadlatch Options

P460 DL25 RH / LH:

Deadlatch (round screw in cylinder type only), complete with flat and radius silver grey faceplates - backset 25mm (1") right hand and left hand available.

Compatible: 460/465/470/475

P460 DL29 RH / LH:

Deadlatch (round screw in cylinder type only), complete with flat and radius silver grey faceplates - backset 29mm (1 1/8") right hand and left hand available.

Compatible: 460/465/470/475

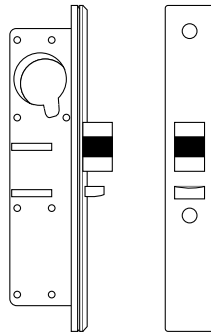

Code Change Method

Requires removal of the lock from the door. The code can be changed by repositioning the tumblers in the code chamber. Locks are supplied with a random code commencing with the 'C' clear button.

Code Free Access

The CL465 and CL475 models provide a Code Free Access mode. These models feature a black dot on the 'Y' button. When the 'Y' button is pressed along with a correct code input, the lever will retract the latch freely until disabled.

TECHNICAL SPECIFICATIONS

FEATURE	DESCRIPTION
Spindle Type	Two part 6mm (1/4") spring loaded spindle
Latch	Two sizes available - sold separately
Handle Options	Lever handle - standard (L) Ball shape knob (B) Stubby lever (SL)
Models	Threaded cylinder and Euro profile cylinder available
Material	Zinc Alloy
Finish	PVD (Physical Vapour Deposition), low maintenance
Finish Colour	Stainless Steel
Non Handed	Locks will fit doors hung on the left or right
Door Thickness	45mm - 55mm (1 3/4" - 2 2/16")
Door Material	Aluminium
Codes	8,191 non sequential code combinations available
Code Storage	Single Code
Buttons	14 stainless steel buttons
Fitting Options	Vertical only
Suitable For	Internal and external use
Keyed Alike	Locks can be supplied keyed alike on request

PRODUCT DIMENSIONS

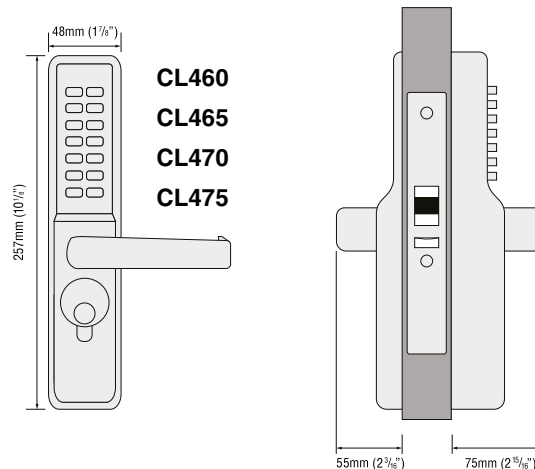



HEAVY DUTY MECHANICAL ACCESS



Heavy duty mechanical locks with large full size lever handles, allowing use as the primary lock on doors.

The CL500 range of mechanical locks offer a variety of options. Allows the user flexibility on how to manage entry - by key, code or code free access. Throwing the deadbolt on the mortice lock models will lock out code users when appropriate. A safety feature ensures that the inside lever handle will retract the deadbolt so as to avoid accidentally locking a person inside the room. Front and back plates can be purchased for use with existing locks.



Easy to install



Suitable for wooden doors



Limited lifetime guarantee*

2,047

Total code combinations

FEATURES

- Large full size lever handles
- Ball knob handle options available
- PVD low maintenance finish
- Code Free access options
- Suitable for internal and external use
- Mortice latch and mortice lock models available
- Tumbler alignment for easy code change
- Large three coil lever return spring suitable for high traffic use
- Selected models available in stainless steel or polished brass finish
- Neoprene seals included
- Codelocks Fire Kit Packs can be fitted to latch locks for 30 or 60 minute fire doors. Tested in accordance with BS EN 1634-1

Tech Spec

LOCK MODELS



Front and Back Plates

Front and back plates only. Use with existing mortice latch or lock. Existing lock must have a fixing hole 22mm (7/8") below follower (spindle).

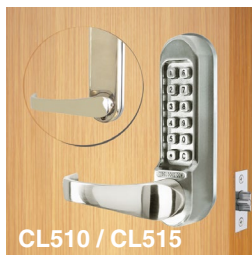

Mortice Latch

Medium duty tubular mortice latch with 'anti-shim' plunger. Latch retracts by turning inside handle freely, or the outside handle after code input.



Back to Back Option (BB)

Medium duty tubular mortice latch. Two coded plates for installation on both sides of the door. Provides coded access in both directions.



Mortice Lock

Euro profile mortice sash lock with deadbolt and latchbolt. With the deadbolt thrown it denies access to code users. Supplied with Euro profile cylinders and three keys.

Two Mortice Latch Sizes Available:

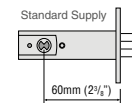

Requires 25mm x 82mm (1" x 3 1/4") hole

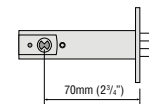

Requires 25mm x 92mm (1" x 3 5/8") hole

ADDITIONAL FEATURES

Code Free Access

The CL505, CL515 and CL525 models provide a Code Free option. The outside lever will retract the latch freely until disabled.

Panic Kit Option

An extra long spindle is provided to work with most single point panic pads or bars.

Split Follower

The CL520 and CL525 Mortice Lock models utilise a split follower as a safety feature. This enables the inside lever to retract the deadbolt and latchbolt, after the deadbolt has been thrown, to prevent an accidental lock in.

Ball Knob

Ball Knob handle options available.



Marine Grade

Selected CL500 models are also available in a black, marine grade finish. Salt spray test up to 1000 hours*

*Tested in-house by Codelocks



PRODUCT DIMENSIONS

CL510 CL515

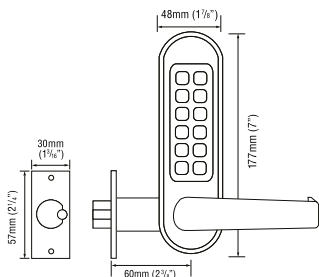

CL520 CL525

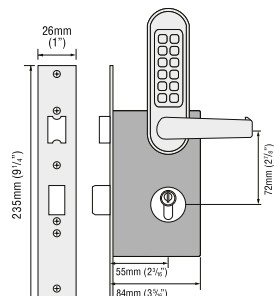

TECHNICAL SPECIFICATIONS

Code Change Method

Requires removal of the lock from the door. The code can be changed by repositioning the tumblers in the code chamber. Locks are supplied with a random code commencing with the 'C' clear button.

FEATURE	DESCRIPTION
Spindle Type	Two part 8mm (5/16") spring loaded spindle
Mortice Latch	Medium duty latch with 'anti-shim' plunger
Mortice Lock	Euro profile mortice sash with deadbolt and latchbolt
Material	Zinc Alloy
Finish	PVD (Physical Vapour Deposition), low maintenance
Finish Colour	Stainless Steel & Polished Brass
Non Handed	Locks will fit doors hung on the left or right
Door Thickness	35mm - 60mm (1 3/8" - 2 3/8")
Codes	2,047 non sequential code combinations available
Code Storage	Single Code
Buttons	12 stainless steel buttons
Fitting Options	Vertical only
Suitable For	Internal and external use
Standards	Codelocks Fire Kits can be fitted to latch locks for 30 or 60 minute fire doors. Tested in accordance with: BS EN 1634-1



QUICK CODE ACCESS



Heavy duty locks with on the door code change capabilities. Simple and quick control of coded access.

Traditionally, changing the code on a mechanical lock requires the lock to be removed from the door; the CL600 however, features QuickCode functionality allowing on the door code changes in seconds. The CL600 QuickCode brings significant advantages to commercial users such as hospitals, schools and local authorities. The locks allow for various ways of managing entry by code, key or code free access via full size lever handles.



Easy to install



On the door code changes



Limited lifetime guarantee*

8,191

Total code combinations

FEATURES

- Full size lever handles with return to door
- Suitable for wooden doors between 35mm - 60mm thick
- PVD low maintenance finish
- Code Free access options
- Suitable for internal and external use
- Mortice latch and mortice lock models available
- Large three coil lever return spring suitable for high traffic use
- Available in a brushed steel finish
- Codelocks Fire Kit Packs can be fitted to latch locks for 30 or 60 minute fire doors. Tested in accordance with BS EN 1634-1

LOCK MODELS



CL600

Front and Back Plates

Front and back plates only. Use with existing mortice latch or lock. Existing lock must have a fixing hole 22mm (7/8") below follower (spindle).



CL610 / CL615

Mortice Latch

Medium duty tubular mortice latch with 'anti-shim' plunger. Latch retracts by turning inside handle freely, or the outside handle after code input.



CL610 / CL615 BB

Back to Back Option (BB)

Medium duty tubular mortice latch. Two coded plates for installation on both sides of the door. Provides coded access in both directions.

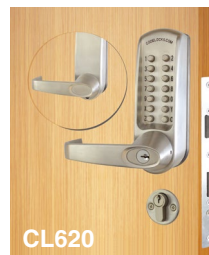

CL620

Mortice Lock

Euro profile mortice sash lock with deadbolt and latchbolt. With the deadbolt thrown it denies access to code users. Supplied with Euro profile cylinder and three keys.

Two Mortice Latch Sizes Available:

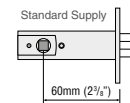

Requires 25mm x 82mm (1" x 3 1/4") hole

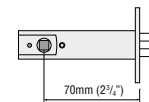

Requires 25mm x 92mm (1" x 3 5/8") hole

ADDITIONAL FEATURES

Code Free Access

The CL615 models provide a Code Free option. The outside lever will retract the latch freely until disabled.

Panic Kit Option

An extra long spindle is provided to work with most single point panic pads or bars.

Split Follower

The CL620 Mortice Lock model utilises a split follower as a safety feature. This enables the inside lever to retract the deadbolt and latchbolt, after the deadbolt has been thrown, to prevent an accidental lock in.

Marine Grade

Selected CL600 models are also available in a black, marine grade finish. Salt spray test up to 1000 hours*

*Tested in-house by Codelocks



TECHNICAL SPECIFICATIONS

Code Change Method

QuickCode allows on the door code changes in seconds!

FEATURE	DESCRIPTION
Spindle Type	Two part 8mm (5/16") spring loaded spindle
Mortice Latch	Medium duty latch with 'anti-shim' plunger
Mortice Lock	Euro profile mortice sash with deadbolt and latchbolt
Material	Zinc Alloy
Finish	PVD (Physical Vapour Deposition), low maintenance
Finish Colour	Brushed Steel
Non Handed	Locks will fit doors hung on the left or right
Door Thickness	35mm - 60mm (1 3/8" - 2 3/8")
Key Override	As standard
Keyed Alike	Locks can be supplied keyed alike on request
Key Cylinder Change	As standard
Code Storage	Single Code
Fitting Options	Vertical only
Suitable For	Internal and external use
Standards	Codelocks Fire Kits can be fitted to latch locks for 30 or 60 minute fire doors. Tested in accordance with: BS EN 1634-1

PRODUCT DIMENSIONS

CL600 CL610 CL615

CL620

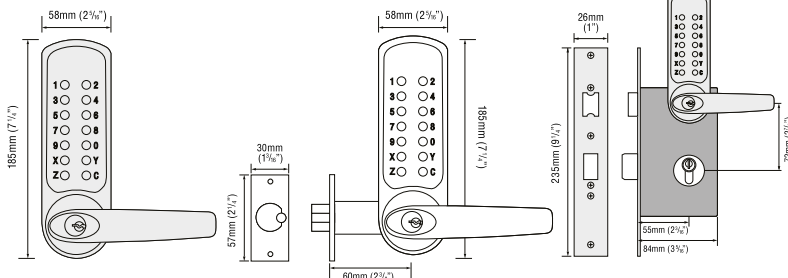

CODELOCKS.COM



Injecting smarter access into the healthcare sector.

“The CL160 mechanical lock provided the perfect solution. The lock was simple to install and could be easily retrofitted onto existing doors. On the door code changes could be made easily, making lock management convenient for staff in terms of maintenance and saving time.”

- RJAH Orthopaedic Hospital



electronic



ELECTRONIC RANGE

Standalone yet effective digital access control.

The functionality of electronic locks provides major benefits over mechanical ones, and unlike other access control solutions, the digital locks do not require complex wiring, ID cards or external power, making them cost effective for many applications.

- Multiple code users
- Remote release functions
- Retrofit opportunities
- On the door programming
- Key override as standard
- Code free access functionality

SIMPLE DIGITAL ACCESS



Fit as a new install or as a quick retrofit when upgrading from basic single code mechanical locks.

CL2000 electronic locks are ideal for a wide range of light duty access control applications. The CL2000 is fully programmable on the door via the keypad with a multiple range of functions. The lock is easily fitted as a new installation or as a quick retrofit when upgrading from basic single code mechanical locks. The locks store up to 80 different User Codes. Codes may be 4, 5 or 6 digits long. Program via the keypad using the Master Code.



Easy to install



On the door programming



Two year guarantee*

80

Up to 80 User Codes

FEATURES

- Key override as standard
- Suitable for wooden doors between 35mm - 60mm thick
- PVD low maintenance finish
- User Codes 4, 5 or 6 digits long
- Allows up to 10 one time User Codes
- Up to 80,000 operations from 2 x 1.5v AA batteries (supplied)
- Surface deadbolt, mortice deadbolt and latch models available
- Remote release connections
- Suitable for internal and external use
- Tamper time out and low battery warning
- Selected models available in brushed steel or polished brass finish
- Codelocks Fire Kit Packs can be fitted to latch locks for 30 or 60 minute fire doors. Tested in accordance with BS EN 1634-1

LOCK MODELS



CL2200

Surface Deadbolt

Bolt slides on inside of door, to lock or unlock. Bolt is moved manually by outside knob after code input and freely by inside knob at all times.



CL2210

Mortice Deadbolt

Bolt extends 25mm (1") beyond door edge when locked. When a valid code is entered the outside knob will retract the bolt.



CL2255

Mortice Latch

Light duty tubular mortice latch retracts via the outside knob after a valid code input. When the door closes, the spring latch will lock the door.

Three Mortice Latch Sizes Available:

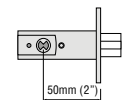

Requires
25mm x 72mm
(1" x 2⁷/₈") hole

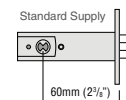

Requires
25mm x 82mm
(1" x 3¹/₄") hole

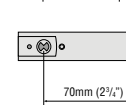

Requires
25mm x 92mm
(1" x 3⁵/₈") hole

ADDITIONAL FEATURES

Code Free Access

All models feature a Code Free option that can be programmed at the keypad using the Master Code.

Code Change Method

Simply program and manage codes via the keypad while the lock is on the door.

Remote Release

Two REM ports are provided for connection to external switches or alarm systems.

Key Override

Key override is a standard feature on all models within the CL2000 range. Locks can be keyed alike on request.

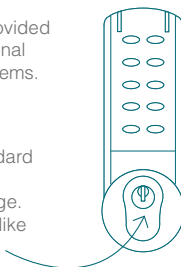

PRODUCT DIMENSIONS

CL2000 CL2200

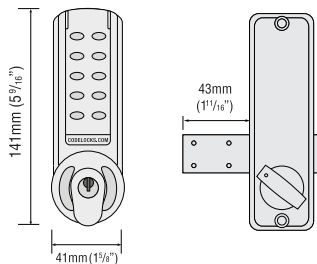

CL2255

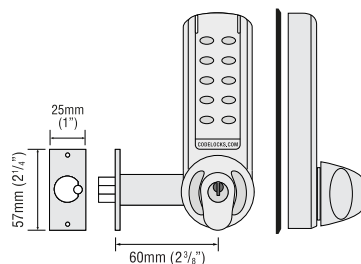

TECHNICAL SPECIFICATIONS

FEATURE	DESCRIPTION
Spindle Type	Flat bar spindle, 8mm adaptor supplied
Operations	Up to 80,000 per set of 2 x 1.5v AA batteries
Mortice Latch	Light duty latch with 'anti-shim' plunger
Low Battery Warning	Red LED will flash on opening to indicate low battery
Battery Override	Via a PP3 battery placed against external contacts
Buttons	Individual stainless steel buttons
Material	Zinc Alloy
Finish	PVD (Physical Vapour Deposition), low maintenance
Finish Colour	Brushed Steel and Polished Brass (CL2255 only)
Non Handed	Locks will fit doors hung on the left or right
Door Thickness	35mm - 60mm (1 ³ / ₈ " - 2 ³ / ₈ ")
Key Override	As standard
Keyed Alike	Locks can be supplied keyed alike on request
Memory	Stores up to 80 User Codes
Fitting Options	Vertical only
Suitable For	Internal and external use
Standards	Codelocks Fire Kits can be fitted to latch locks for 30 or 60 minute fire doors. Tested in accordance with: BS EN 1634-1

VERSATILE ACCESS CONTROL



The CL4000 electronic range are medium duty locks with multiple functions and full size lever handles.

The CL4000 locks are a stylish and contemporary design. Fully programmable on the door via the keypad with a multiple range of functions making them particularly suitable for use in health, educational, commercial and residential environments.



Easy to
install



On the door
programming



Two year
guarantee*

80

Up to 80
User Codes

FEATURES

- Key override as standard and front cylinder change
- Suitable for wooden doors between 35mm - 60mm thick
- PVD low maintenance finish
- User Codes 4, 5 or 6 digits long
- Allows up to 10 one time User Codes
- Up to 200,000 operations from 4 x AA batteries (supplied)
- Mortice deadbolt and latch models available
- Remote release connections
- Suitable for internal and external use
- Lever or knob handle options available
- Tamper time out and low battery warning
- Locked and unlocked LED indicator option
- Selected models available in stainless steel or polished brass finish
- Codelocks Fire Kit Packs can be fitted to latch locks for 30 or 60 minute fire doors. Tested in accordance with BS EN 1634-1

Tech
Spec



LOCK MODELS



CL4010

Mortise Latch

Medium duty tubular mortise latch retracts via the outside knob after a valid code input. When the door closes, the spring latch will lock the door.



CL4020

Mortise Lock

Euro profile mortise sash lock with deadbolt and latchbolt. With the deadbolt thrown it denies access to code users. Supplied with Euro profile cylinders and three keys.

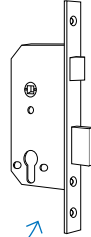

Two Mortise Latch Sizes Available:

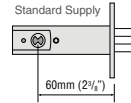

Requires 25mm x 82mm (1" x 3 1/4") hole

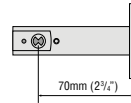

Requires 25mm x 92mm (1" x 3 5/8") hole



Handle Options
Lever or knob handles available for CL4010.

ADDITIONAL FEATURES

Storeroom Function

Fitted as standard i.e. the latch can be retracted by turning the key.

Classroom Function

Tailpiece supplied to allow (when fitted) lock to be left in Code Free option when the key is removed.

Code Management

Program and manage codes via the keypad while the lock is on the door. All models also feature a Code Free option.

Remote Release

Two REM ports are provided for connection to external switches or alarm systems.

PRODUCT DIMENSIONS

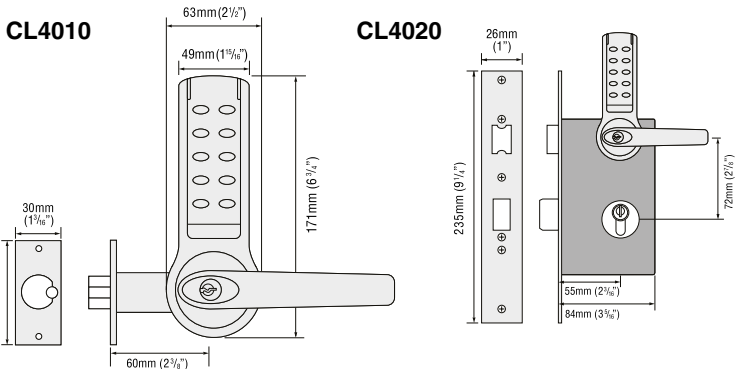

TECHNICAL SPECIFICATIONS

FEATURE	DESCRIPTION
Spindle Type	8mm (5/16") spring loaded spindle
Operations	Up to 200,000 per set of 4 x AA batteries
Mortise Latch	Medium duty latch with 'anti-shim' plunger
Low Battery Warning	Red LED will flash on opening to indicate low battery
Buttons	Individual stainless steel buttons
Material	Zinc Alloy
Finish	PVD (Physical Vapour Deposition), low maintenance
Finish Colour	Stainless Steel and Polished Brass
Non Handed	Locks will fit doors hung on the left or right
Door Thickness	35mm - 60mm (1 3/8" - 2 3/8")
Key Override	As standard and front cylinder change
Keyed Alike	Locks can be supplied keyed alike on request
Memory	Stores up to 80 User Codes
Fitting Options	Vertical only
Suitable For	Internal and external use
Standards	Codelocks Fire Kits can be fitted to latch locks for 30 or 60 minute fire doors. Tested in accordance with: BS EN 1634-1



GLASS DOOR CONTROL



The CL4000GD lock is designed for use on internal doors, and will easily fit new installations or can be quickly retrofitted.

The CL4000GD is a medium duty electronic patch door lock offering all the functions of the CL4000. Suitable for inswing doors, the lock fits existing Rondo type glass door preparations. As standard the CL4000GD is supplied with a flat strike plate for fitting to solid door frames. When fitting to a glass door with a glass side panel you will need to buy the patch strike box.



Easy to install



On the door programming



Two year guarantee*

80

Up to 80 User Codes

FEATURES

- Key override as standard
- Up to 140,000 operations from 4 x 'N' cells (supplied)
- PVD low maintenance brushed steel finish
- User Codes 4, 5 or 6 digits long
- Allows up to 10 one time User Codes
- Lever handle supplied as either right or left hand
- Tamper time out and low battery warning
- Locked and unlocked LED indicator option
- Suitable for inswing doors only
- Suitable for internal use

LOCK MODELS



Electronic Patch Door Lock

Medium duty brushed steel latchbolt head with 8mm ($\frac{5}{16}$ ") follower. Supplied with a flat strike plate for fitting to a solid door frame. Outside lever turns freely without operating the latchbolt. When a valid code is entered and the blue LED lights up, the lever will retract the latchbolt. When the door closes the spring latch will automatically lock the door. The key will open the door for management functions. The key may be used to set the lock into Code Free option so that anyone can open the door without using a code (classroom function tailpiece required). Code Free option can also be programmed via the keypad.

FEATURES

Code Management

Program and manage codes via the keypad while the lock is on the door. All models also feature a Code Free option.

Remote Release

Two REM ports are provided for connection to external switches or alarm systems.

Storeroom Function

Fitted as standard i.e. the latch can be retracted by turning the key.

Classroom Function

Tailpiece supplied to allow (when fitted) lock to be left in Code Free option when the key is removed.

Strike Box

To use when installing to a glass door with a glass side panel as opposed to a solid frame. Available to purchase as a separate product.



TECHNICAL SPECIFICATIONS

FEATURE	DESCRIPTION
Spindle Type	8mm ($\frac{5}{16}$ ") spring loaded spindle
Operations	Up to 140,000 per set of 4 x 'N' cells
Mortice Latch	Medium duty latch with 'anti-shim' plunger
Low Battery Warning	Red LED will flash on opening to indicate low battery
Buttons	Individual stainless steel buttons
Material	Zinc Alloy
Finish	PVD (Physical Vapour Deposition), low maintenance
Finish Colour	Brushed Steel
Door Thickness	8mm - 15mm ($\frac{5}{16}$ " - $^{10}/_{16}$ ")
Key Override	As standard and front cylinder change
Keyed Alike	Locks can be supplied keyed alike on request
Memory	Stores up to 80 User Codes
Fitting Options	Vertical only
Suitable For	Internal use
Handed	Lever handle supplied as either right hand (RH) or left hand (LH) for inswing doors only

PRODUCT DIMENSIONS

CL4000GD

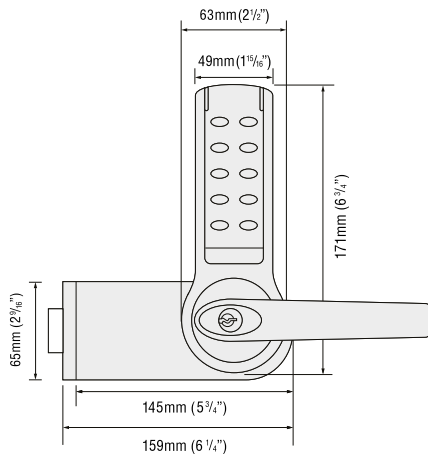

Electronic Patch Door Lock with Patch Strike Template

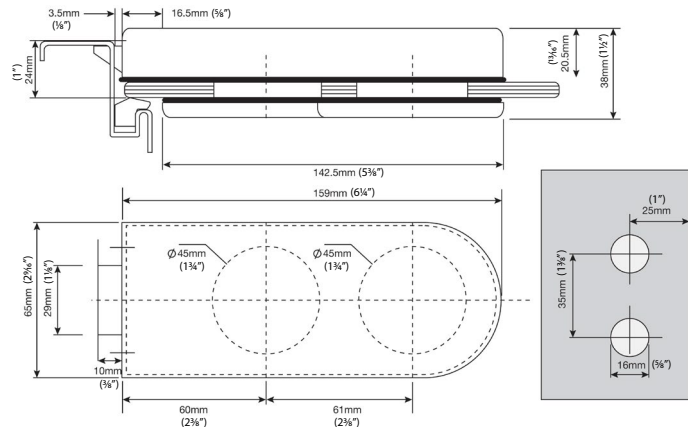



ULTIMATE HEAVY DUTY CODELOCK



Locks in the CL5000 range are the ultimate standalone electronic door locks. Top of the range digital locks tested to Grade 2 ANSI A156.2/A156.25.

Heavy duty locks for use in high traffic applications. The stylish design incorporates all the features of CL2000 and CL4000, in a larger, more robust assembly. Unlike the other electronic locks, the CL5000 has a conventional 3x4 button keypad layout for instant familiarity, providing quick programming with a multiple range of functions. Particularly suitable for use in health, educational, commercial and residential environments.



Easy to install



On the door programming



Two year guarantee*

80

Up to 80 User Codes

FEATURES

- Key override and front cylinder change
- Suitable for wooden doors between 35mm - 60mm thick
- PVD low maintenance finish
- User Codes 4, 5 or 6 digits long
- Allows up to 10 one time User Codes
- Up to 200,000 operations from 4 x AA batteries (supplied)
- Remote release connections
- Suitable for internal and external use
- Tamper time out and low battery warning
- Locked and unlocked LED indicator option
- Tested to Grade 2 ANSI A156.2 / A156.25
- UL/ULC Fire Rating 3 hours (when fitted with US fire kit)
- Codelocks Fire Kit Packs can be fitted to latch locks for 30 or 60 minute fire doors. Tested in accordance with BS EN 1634-1

LOCK MODELS



CL5000 PK

Panic Access Kit

Front plate only. Install with new or existing panic equipment. The follower on the panic equipment must return to square to align with follower on the lock.



CL5010

Mortice Latch

Medium duty tubular mortice latch retracts via the outside knob after a valid code input. When the door closes, the spring latch will lock the door.



CL5010 BB

Back to Back Option (BB)

Medium duty tubular mortice latch. Two coded plates for installation on both sides of the door. Provides coded access in both directions.



CL5020

Mortice Lock

Euro profile mortice sash lock with deadbolt and latchbolt. With the deadbolt thrown it denies access to code users. Supplied with Euro profile cylinders and three keys.

Two Mortice Latch Sizes Available:

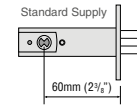

Requires 25mm x 82mm (1" x 3 1/4") hole

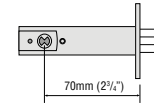

Requires 25mm x 92mm (1" x 3 5/8") hole

ADDITIONAL FEATURES

Storeroom Function

Fitted as standard i.e. the latch can be retracted by turning the key.

Code Management

Program and manage codes via the keypad while the lock is on the door. All models also feature a Code Free option.

Classroom Function

Tailpiece supplied to allow (when fitted) lock to be left in Code Free option when the key is removed.

Remote Release

Two REM ports are provided for connection to external switches or alarm systems.

PRODUCT DIMENSIONS

CL5010

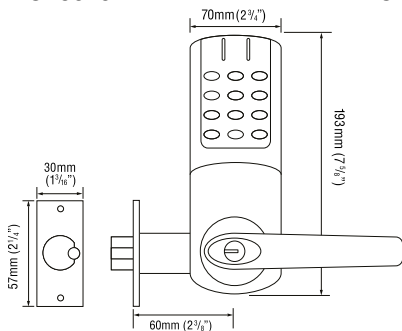

CL5020

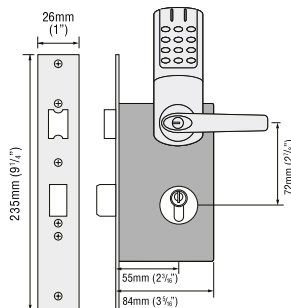

TECHNICAL SPECIFICATIONS

FEATURE	DESCRIPTION
Spindle Type	Two part 8mm (5/16") spring loaded spindle
Operations	Up to 200,000 per set of 4 x AA batteries, 8 x AAA for CL5010 BB model
Mortice Latch	Medium duty latch with 'anti-shim' plunger
Low Battery Warning	Red LED will flash on opening to indicate low battery
Buttons	Individual stainless steel buttons
Material	Zinc Alloy
Finish	PVD (Physical Vapour Deposition), low maintenance
Finish Colour	Brushed Steel and Polished Brass
Non Handed	Locks will fit doors hung on the left or right
Door Thickness	35mm - 60mm (1 3/8" - 2 3/8")
Key Override	As standard and front cylinder change
Keyed Alike	Locks can be supplied keyed alike on request
Memory	Stores up to 80 User Codes
Fitting Options	Vertical only
Suitable For	Internal and external use
Standards	Codelocks Fire Kits can be fitted to latch locks for 30 or 60 minute fire doors. Tested in accordance with: BS EN 1634-1



CL5000 NetCode®

Codelocks proudly presents the CL5000 NetCode®. With the original CL5000 having stood strong since its launch in 2004, the CL5000 NetCode® is an evolution of a time-tested classic.



Easy to
install



On the door
programming



Two year
guarantee¹

80

Up to 80
User Codes

FEATURES

- NetCode® technology
- Up to 80 User Codes
- Heavy duty suited to high traffic
- Easy to install and operate
- Two year guarantee¹
- 8 digit Master and Sub-Master Code
- 4, 5 or 6 digit User Codes
- Code Free Mode (Passage Function)
- Battery level check
- 3 types of NetCodes
- Fire rated to BS EN 1634-1²

ABOUT CL5000 NetCode®

The addition of NetCode® technology unlocks added benefits of temporary, time-sensitive access codes that provide an increased level of control. Enjoy the flexibility and convenience of remote access, granting or revoking entry from afar via the Codelocks Connect Portal.

Powered by batteries, operation of the CL5000 is hassle-free, eliminating complex wiring. Whilst offering enhanced NetCode® capabilities, the reliability and durability of the well-known CL5000 that made (and continues to make) it a bestseller is retained.

ADDITIONAL NETCODE® FEATURES

Block Previous NetCode®

This feature automatically blocks the last used NetCode® when a new NetCode® is entered.

Block Specific NetCode®

Block a specific NetCode® directly on the lock using either the Master Code or another valid NetCode®.



All NetCode® locks are registered via the online Codelocks Connect Portal. Once registered, NetCodes can be generated and shared via email and SMS. A built-in history provides an audit of all NetCodes created for each lock.

Codelocks also provide a simple Application Programming Interface (API) to enable customers to generate NetCodes via their own applications. Please contact Codelocks to discuss these options.



Also available in **Solid Black** finish

PRODUCT DIMENSIONS

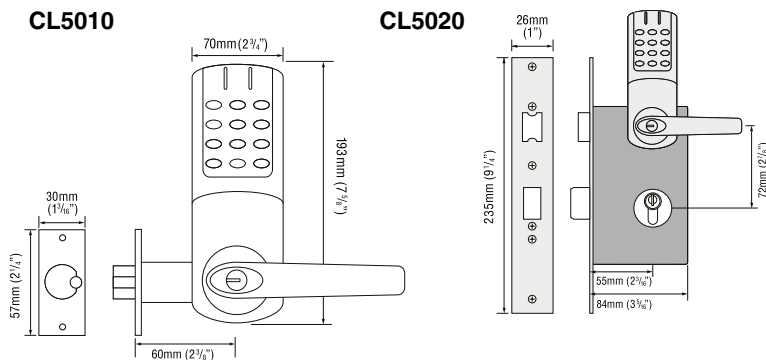

LOCK MODELS



Mortice Latch

Medium duty tubular mortice latch. When the door closes, the spring latch will lock the door.



Mortice Lock

Euro profile mortice lock with deadbolt and latchbolt. Engaged deadbolt denies access to code users. Supplied with Euro profile cylinders and three keys.



Panic Kit

Front plate only. Install with new or existing panic equipment. The follower on the panic equipment must return to square to align with follower on the lock.



TECHNICAL SPECIFICATIONS

Feature	Description
Spindle Type	8mm (5/16") spring loaded spindle
Mortice Latch	60mm or 70mm latch options
Operations	Up to 200,000 per set of 4 x AA batteries
Low Battery Warning	Red LED will flash on opening to indicate low battery
Buttons	Individual stainless steel buttons
Material	Zinc Alloy
Finish	PVD (Physical Vapour Deposition), low maintenance
Finish Colours	Brushed Steel, Solid Black
Non Handed	Locks will fit doors hung on the left or right
Door Thickness	35mm - 60mm (1 3/8" - 2 3/8")
Key Override	As standard
Keyed Alike	Locks can be supplied keyed alike on request
Access Methods	Via code, NetCode® or override key
Memory	80 User Codes, 10 One-Time User Codes
NetCode® Types	Standard Single-Use/Multi-Use, Rental Multi-Use
Suitable For	Internal and external use
Fire Rated	²Codelocks Fire Kits can be fitted to latch models for 30 or 60 minute fire doors. Tested in accordance with BS EN 1634-1.



1

2

3

4

5

6

7

8

9

*

0

#

CODELOCKS.COM

CODELOCKS.COM

Access control providing peace of mind in the education sector.

“Electronic keyless locks are so much more convenient than traditional locks and keys; it’s far easier and cheaper to change an access code than it is to keep replacing lost keys. As the locks can be added one door at a time with minimum amount of disruption, they are a simple and cost effective solution too.”

- Rush Common School



Weather protection



Code protection



Easy to install

PINGuard™
by Codelocks

PINGuard™

by Codelocks



XT1



XT2



XT3

PINGuard™ by Codelocks' range of covers are now available in three sizes to suit a wide range of Codelocks mechanical and electronic locks. The covers provide additional PIN security whilst also protecting your Codelocks from adverse weather conditions.

The covers are flexible, high grade polymer that fit behind the lock, improving the gasket seal and preventing water ingress making them an ideal external accessory to your Codelocks digital standalone lock.

PROTECT YOUR PIN

Keep prying eyes away from your entry code! Add to external and internal doors where the PIN needs protecting from view.

PROTECT YOUR LOCK

PINGuard™ by Codelocks significantly reduces the effects of water ingress. The added weather protection will extend the life of your lock. Protect the finish, the keypad and overall appearance of your Codelocks product. Small, medium and large PINGuard™ by Codelocks available, suitable for external applications; gates, sheds, out buildings, work sites etc.

KEY FEATURES

- PIN and weather protection
- Quick and easy fit
- Protection from rain exposure
- Protection from sub-zero temperatures
- Lock life extension
- New and existing lock installations
- Three sizes available
- Suitable for external applications

TECHNICAL SPECIFICATIONS

FEATURE	DESCRIPTION
Finish	Dark Grey
Material	High grade polymer
XT1 Dimensions	Depth: 57mm (2 1/4") Suitable for CL100, CL200, CL2000 lock range
XT2 Dimensions	Depth: 71mm (2 3/4") Suitable for CL500 lock range
XT3 Dimensions	Depth: 65mm (2 9/16") Suitable for CL600, CL4000, CL4500, CL5000, CL5500 lock range

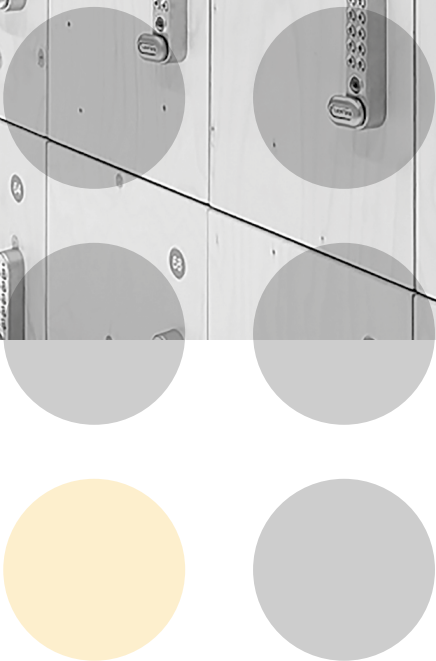

KitLock 
by CodeLocks

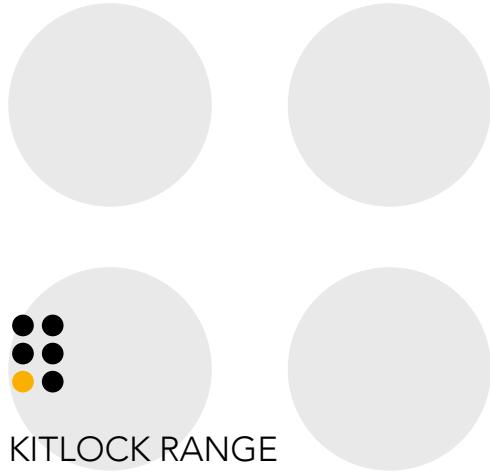

KITLOCK RANGE

Go Keyless. Go KitLock.

KitLock is a stylish and convenient alternative to traditional locks and keys, using four digit codes and smart cards rather than a key to secure cupboards, drawers, lockers and cabinets in gyms, leisure centres, spas, schools, hospitals, data centres, offices, warehouses - any cabinet and locker application!

- On the door programming
- Quick retrofit to existing cam locks
- Silver grey or black finishes
- NetCode® technology
- User-friendly
- Smart card access options

SIMPLE MECHANICAL KITLOCK



Introducing the KitLock KL10. Designed with simplicity in mind, the KL10 offers mechanical keyless access suitable for a variety of lockers, cabinets and cupboards.

A durable, compact, easy to use mechanical lock. Designed to be both retrofitted or installed on new cabinets. Changing or resetting the code can be completed easily whilst the lock is still on the door, or if the code has been forgotten it can be retrieved using the master key.



Easy to install



Mechanical keyless access



One year guarantee*



Private and Public Functions

FEATURES

- Easy to install and retrofit
- Locked and unlocked indicators
- 4 wheel code combination
- Up to 10,000 unique combinations
- Black powder coated finish
- Private and Public Function
- Easy grip outer casing
- Code retrieval function
- Master key available
- Suitable for internal use only

FUNCTIONS



Private Function

The KL10 Private Function is ideal for use where the same, personal 4 digit code will be repeatedly used, e.g. an employee with the same locker/drawer in the workplace.



Public Function

The KL10 Public Function is ideal for short term, multiple occupancy applications. The user enters a personal four digit code, this locks the lock. The same code is entered once only to open the lock, the lock remains open ready for the next user.



Code Retrieval

This function requires the Master Key (sold separately). Allows a code to be retrieved should it be forgotten or emergency access is required.



TECHNICAL SPECIFICATIONS

FEATURE	DESCRIPTION
Functions	Private or Public Function
Housing	Zinc Alloy
Code Length	4 digit
Code Storage	Single code
Suitable For	Internal applications only
Spindle Length	Fixed spindle suitable up to 18mm (11/16") thick
Handing	Non-handed
Door Prep	19mm (3/4") diameter
Indicators	Locked / unlocked
Fixings	Nut supplied - additional washer / clip available separately
Cam	44.7mm (1 3/4") straight cam and 50mm (2") crank cam supplied with retail boxed product

Note: Not suitable for Chlorine environments.

PRODUCT DIMENSIONS

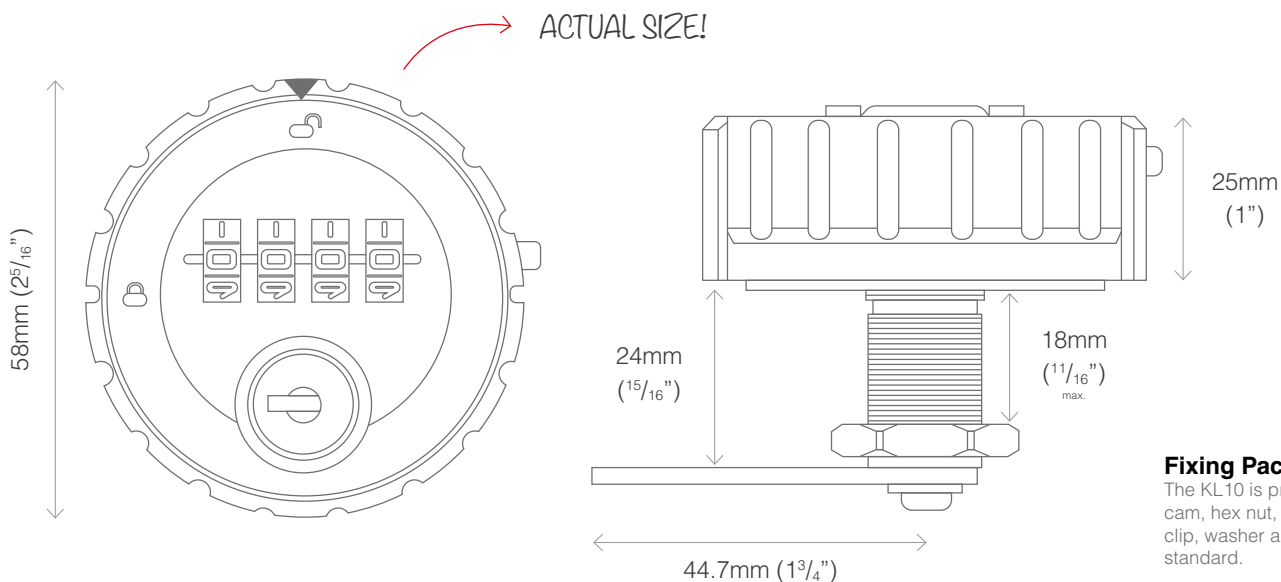

ANTI-VANDAL MECHANICAL KITLOCK



Simple, tough and good value for money, the KL15 offers mechanical keyless access with Private or Public Function models suitable for a variety of locker and cabinet applications.

The KL15 can be surface mounted with an ergonomically designed surface trim plate that provides additional grip allowing ease of opening. If it's a sleek look that will better suit the application, the KL15 can also be flush fitted.



Easy to install



Mechanical keyless access



One year guarantee*



Private and Public Functions

FEATURES

- Code retrieval function
- Flush or surface mounted
- Anti-vandal handle
- Salt spray tested
- High / low temperature tested
- High / low humidity tested
- 4 wheel combination
- Up to 10,000 unique combinations
- Locked / unlocked indicators
- Private and Public Function
- Suitable for internal and external applications

FUNCTIONS



Private Function

The KL15 Private Function is ideal for use where the same, personal 4 digit code will be repeatedly used, e.g. an employee with the same locker/drawer in the workplace.



Public Function

The KL15 Public Function is ideal for short term, multiple occupancy applications. The user enters a personal four digit code, this locks the lock. The same code is entered once only to open the lock, the lock remains open ready for the next user.



Code Retrieval

Use the Master Key to retrieve the forgotten code by simply turning the dials individually until the correct code 'clicks' into place.



Installation

The KL15 can be installed to fit either flush or surface mounted applications. All necessary fixings are supplied with the lock.



TECHNICAL SPECIFICATIONS

FEATURE	DESCRIPTION
Functions	Private or Public Function
Code Length	4 digit
Code Storage	Single code
Suitable For	Internal and external applications
Surface Mount	Fixed spindle suitable for panel thickness 0.8mm - 18mm ($\frac{1}{32}$ " - $1\frac{1}{16}$ ")
Flush Fit	Suitable for panel thickness 0.8mm - 36mm ($\frac{1}{32}$ " - $1\frac{3}{8}$ ")
Handing	Vertical, right hand and left hand
Indicators	Locked (red) / unlocked (green)
Fixings	All surface mount and flush fit fixings supplied as standard
Cam	Flat and cranked cam supplied as standard

PRODUCT DIMENSIONS



AUTO SCRAMBLE MECHANICAL



Designed with simplicity in mind, the KL20 offers mechanical keyless access suitable for a variety of lockers, cabinets and cupboards.

A simple robust mechanical lock. Tough alloy front and handle. Flush mounted ideal for personal storage in offices, schools and colleges. The user selects their own 4 digit code and this remains unchanged until they wish to alter it. The user can change their code at anytime and the KL20 has the added security and convenience of an auto scrambling function. The dials automatically scramble to 0-0-0-0 when the lock is used, thus hiding the user code from others.



Easy to
install



Mechanical
keyless access



One year
guarantee*



Private Function
Only

FEATURES

- No keys to manage
- Code retrieval function
- Auto code scramble function
- 4 wheel code combination
- Black powder coated finish
- Locked / unlocked indicators
- Available vertical, right hand and left hand
- Private Function only
- Suitable for indoor use only

FUNCTIONS



AUTO
SCRAMBLE!



Private Function

This function is used where the same code will be repeatedly used, e.g. an employee with the same locker/drawer in the workplace.



Code Retrieval

This function requires the Master Key (sold separately). Allows a code to be retrieved should it be forgotten or emergency access is required.

TECHNICAL SPECIFICATIONS

FEATURE	DESCRIPTION
Functions	Private Function only
Housing	Zinc Alloy front - plastic rear
Code Length	4 digit
Code Storage	Single code
Suitable For	Internal applications only
Spindle Length	Fixed spindle suitable for panel thickness 0.8mm - 22mm ($\frac{1}{32}$ " - $\frac{7}{8}$ ")
Handing	Vertical, right hand and left hand
Door Prep	83mm x 27mm ($3\frac{1}{4}$ " - $1\frac{1}{16}$ ")
Indicators	Locked (red) / unlocked (green)
Fixings	Back plate(s) and cam supplied Additional back plate and cam available
Cam	40mm ($1\frac{9}{16}$ ") straight cam supplied

Note: Not suitable for Chlorine environments.

PRODUCT DIMENSIONS

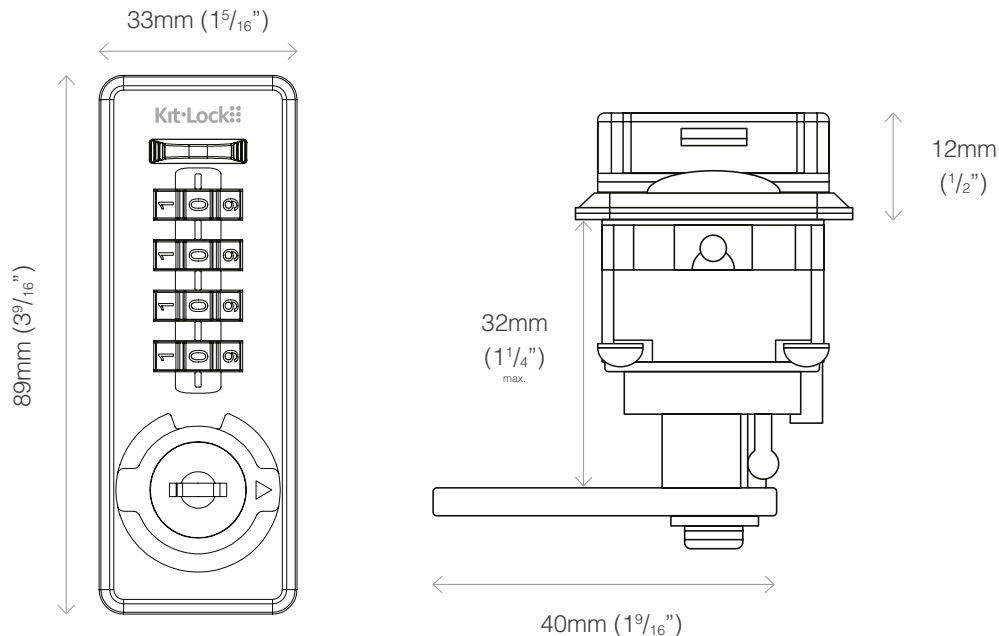

Fixing Pack

The KL20 is provided with a straight cam, back plate(s) and fixing screws as standard. An additional back plate and cranked cam are available to purchase separately.



SIMPLE KEYLESS ACCESS



The KL1000 Classic is a compact digital lock ideal for replacing keyed cam locks commonly supplied on a wide range of lockers, cabinets and cupboards.

This neat lock is easy to fit, taking just a few minutes to remove the existing cam lock and making an additional top fixing. KL1000 Classic can also be fitted to a locker or cabinet that does not have an existing locking device - just drill another hole. Once in place the lock will perform up to 15,000 openings on just two AAA batteries. Access control without the need for keys.



Easy to
install



On the door
programming



Two year
guarantee*



Private and
Public Functions

FEATURES

- 11 button keypad
- 8 digit Master and Sub-Master Code
- 4 digit User Code
- 6 digit Technician Code
- Left hand and right hand versions available
- Up to 15,000 operations from 2 x AAA batteries (supplied)
- Battery override
- Slam latch accessory available
- IP55 rated when fitted with gasket
- All parts / fixings / templates included

FUNCTIONS



Private Function

This is the default function and is already pre-programmed in new locks. This function is used where the same code will be repeatedly used, e.g. an employee with the same locker/drawer in the workplace.



Public Function

In this function the KitLock operates with a single User Code. The user enters a personal four digit code, this locks the lock. The same code is entered once only to open the lock before automatically being erased and ready for the next user. This function is used for short term, multiple occupancy applications, e.g. hot desking in an office or a locker in a sports club.

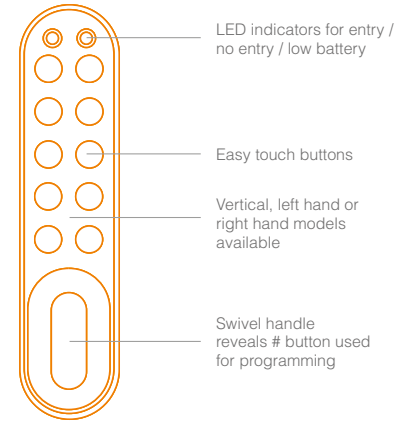

LED indicators for entry / no entry / low battery

Easy touch buttons

Vertical, left hand or right hand models available

Swivel handle reveals # button used for programming

PRODUCT DIMENSIONS



Code Management

KL1000 Classic has four code levels available:

- 8 digit Master Code
- 8 digit Sub-Master Code
- 4 digit User Code
- 6 digit Technician Code

The KitLock is supplied with two factory set codes:

- Master Code
- User Code

Before installing, change the Master and User Code by following the Programming and Operating Instructions.

Easy Installation

Everything you need is included to ensure a quick and easy installation.

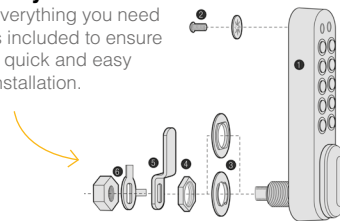

TECHNICAL SPECIFICATIONS

FEATURE	DESCRIPTION
Operations	Up to 15,000 opening per 2 x 1.5 AAA batteries
Battery Override	A 9 volt PP3 battery can be placed against external contacts
Low Battery Warning	Red LED will flash on opening to indicate low battery
Functions	Private and Public
Buttons	11 individual round buttons
Material	Zinc Alloy
Finish Colour	Silver grey and black as standard
Door Thickness	Ready to fit doors up to 25mm (1")
Memory	Non-volatile memory will be retained
Fitting	Easy to install and program
Fitting Options	Vertical, right hand and left hand models
IP55 Rated	When used with rubber gasket (available separately)
Slam Latch	Retrofit to existing KL1000 Classic locks or purchase for new locks. Easy shutting.

Note: Not suitable for Chlorine environments.



SMART CARD ACCESS



The KL1000 RFID is a simple, smart card KitLock providing codeless and keyless access to lockers, cabinets, cupboards and enclosures.

The KL1000 RFID KitLock offers functions for single users (Private Function) and short term use by multiple users (Public Function). The KL1000 RFID can be easily fitted to replace an existing cam lock, or to fit to a new locker or cabinet that does not have an existing locking device. The lock will perform up to 15,000 openings on just two AAA batteries.



Easy to install



Smart card access control



Two year guarantee*



Private and Public Functions

FEATURES

- MIFARE® compatible
- Master User Card
- Technician Card
- Public Pairing Feature**
- Any orientation
- Up to 15,000 operations from 2 x AAA batteries (supplied)
- Battery override
- Slam latch accessory available
- IP55 rated when fitted with gasket
- All parts / fixings / templates included

FUNCTIONS



Private Function

This is intended for use where there is a single user. Up to 50 individual MIFARE® cards can be registered on the lock and only those registered cards can continue to unlock that lock. The Master Card is used to open a lock, register a new User Card and remove a User Card. The Technician Card is not available in this function. Dedicated and existing MIFARE® cards can be used, no need to purchase new smart cards.



Public Function

Suitable for short term use by different users. Touch a MIFARE® smart card to lock the lock and then use the same card to unlock the lock, leaving the lock in that unlocked state for any other compatible card to be used. Pre-registration of the card is not required and any new or existing MIFARE® card, fob or wristband can be used. Suitable for use in short-term multi-occupancy applications such as leisure centres, spas and hotels.

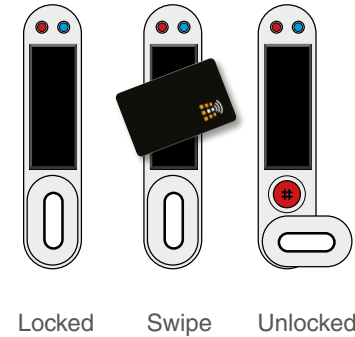

Locked

Swipe

Unlocked

PRODUCT DIMENSIONS



Card Management

Master Card

The Master Card is used to open the lock and delete the currently in-use User Card. The lock will return to an unlocked state.

Technician Card

The Technician Card is used to open the lock and retain the currently in use User Card. The lock will return to a locked state.

Public Pairing Feature

The Public Pairing Feature prevents the same card from locking multiple locks that are operating in Public Function.

** Public Pairing Feature is only supported with MIFARE® classic smart cards.

Easy Installation

Everything you need is included to ensure a quick and easy installation.

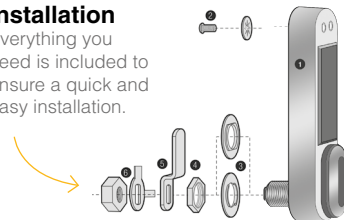

TECHNICAL SPECIFICATIONS

FEATURE	DESCRIPTION
Operations	Up to 15,000 opening per 2 x 1.5 AAA batteries
Battery Override	A 9 volt PP3 battery can be placed against external contacts
Low Battery Warning	Red LED will flash on opening to indicate low battery
Functions	Private and Public
Material	Zinc Alloy
Finish Colour	Silver grey
Door Thickness	Ready to fit doors up to 25mm (1")
Memory	Non-volatile memory will be retained
Fitting	Easy to install and program
Fitting Options	Any orientation in 45 degree increments
IP55 Rated	When used with rubber gasket (available separately)
Slam Latch	Retrofit to existing KL1000 RFID locks or purchase for new locks. Easy shutting.

Note: Not suitable for Chlorine environments.

THIRD GENERATION KL1000



Applying advanced technology to our core products. The KL1000 G3 KitLock offers key override and front battery change capabilities providing ease of use and peace of mind.

The updated chrome effect back panel and handle finishes reflect their surroundings giving the lock a slimmer, more subtle aesthetic. Sharing the same fittings & fixings as the KL1000 Classic, this lock is easily retrofitted, ideal for upgrading existing cabinet and locker installations with increased flexibility and convenience for both guests and staff.



Easy to install
or retrofit



Key Override
capability



Front battery
change



Private and
Public Functions

FEATURES

- Keyless entry
- Easy install or retrofit
- Front battery change
- Key Override
- Private and Public Functions
- Up to 20 User Codes
- Auto-unlock after a set time
- Slam latch accessory available
- Black Chrome / Silver Chrome finishes
- Two year guarantee*

FEATURES



Private Function

This function is used where the same code will be repeatedly used, e.g. an employee with the same locker/drawer in the workplace.



Public Function

This is the default function and is already pre-programmed in new locks. In this function the KitLock operates with a single User Code. The user enters a personal four digit code, this locks the lock. The same code is entered once only to open the lock before automatically being erased and ready for the next user. This function is used for short term, multiple occupancy applications, e.g. hot desking in an office or a locker in a sports club.



Key Override

Allows key holders to access the locker in the event of a forgotten code or an emergency. Override key available separately.



Front Battery Change

The KL1000 G3 battery compartment can be accessed via the front of the lock, eliminating the need for battery override. Entering a valid code and turning the handle reveals a security screw which, once removed, allows the cover to slide up and batteries to be replaced.



24hr Auto-Unlock Countdown Timer

When operating in Public Function, the KL1000 G3 can be programmed to auto-unlock between 1 and 24 hours after locking**, saving valuable locker management time.



20 User Codes

The KL1000 G3 offers up to 20 unique 4 digit User Codes when operating in Private Function, thus allowing a single cabinet to be accessed by multiple users.



Easy Retrofit

The KL1000 G3 shares the same fittings and fixings as all KL1000 KitLocks, therefore existing installations can be easily upgraded and retrofitted in a matter of minutes.



KL1000
Third generation.

TECHNICAL SPECIFICATIONS

FEATURE	DESCRIPTION
Code Length	8 digit Master and Sub-Master Code, 6 digit Technician Code, 4 digit User Code
Key Override	Override key available separately
Operations	Up to 100,000 operations per 2 x AAA batteries
Low Battery Warning	Red LED will flash on opening to indicate low battery
Fitting Options	Vertical, right and left hand models
IP54 Rated	When used with gasket (available separately) IP55 available for special order
Cam	Flat and cranked cam supplied
Door thickness	Ready to fit doors up to 25mm (1")
Spindle	Fitted with 24mm (15/16") spindle as standard, optional 10mm (3/8") and 29mm (1 1/8") spindles supplied
Slam Latch	Retrofit to existing KL1000 G3 locks or purchase for new locks (available separately)

Note: Not suitable for poolside lockers.

**Up to 24hrs. Locks can be configured to auto-unlock between 1-24hrs, within +/- 30 minutes of the time period.



ACTIVATE GENERATE CONTROL



The KL1000 NetCode® provides the smart way to generate time-sensitive codes for a wide range of lockers and cabinets.

Through the online Codelocks Connect Portal or via the Codelocks simple API, you can create codes that have a specified start date, time and duration. Once the duration expires, the codes no longer work. Using time-sensitive codes is a more convenient way to grant access as the code will not work outside a designated timeslot. Issue codes to visiting service engineers, delivery personnel (drop boxes), and medium-term locker rental. Generated codes can be sent by email or SMS.**



Easy to install



On the door programming



Two year guarantee*



Private and Public Functions

FEATURES

- Create codes for short, medium and long term
- Web based NetCode® generation
- Send generated codes via email or SMS**
- Three modes of operation
- Four types of NetCode®
- Up to 15,000 operations from 2 x AAA batteries (supplied)
- Battery override
- No WiFi connection required
- 11 button keypad
- Master, Sub-Master, User and Technician Codes
- IP55 rated when fitted with gasket
- All parts / fixings / templates included

FUNCTIONS



Three Modes of Operation

The KL1000 NetCode® retains the standard Public and Private Functions.

NetCode®

This function allows temporary access. Create date and time-sensitive codes via the Codelocks Connect Portal or your own application with our simple API (application programming interface).

Private Function

This function is used where the same code will be repeatedly used. Choose a single four digit User Code to use multiple times. Ideal for use where the lock is allocated to a single person for a long period of time.

Public Function

This function is used for short-term, multiple occupancy applications. Enter a four digit User Code to lock the locker, the same code is used to unlock. The lock remains open, ready for a new user and a new code.

TYPES OF NETCODE®

Four types of NetCode® are available:

- Short term multi-use codes with durations from 1 to 12 hours and 1 to 7 days
- Short term single-use codes with durations from 1 to 12 hours and 1 to 7 days
- Medium term codes with durations from 1 to 21 days
- Long term codes that work for periods of up to 1 year

ADDITIONAL NETCODE® FEATURES

Block Previous NetCode®

This feature automatically blocks the last used NetCode® when a new NetCode® is entered.

Block Specific NetCode®

Block a specific NetCode® directly on the lock using either the Master Code or another valid NetCode®.

Mode Restrictions

Choose which types of NetCode® to support. This is a useful feature if the number of potentially available NetCodes needs to be reduced.

Personal User Code

Allow a NetCode® user to create a personal 4 digit number that retains the same validity period as their originally allocated NetCode®.

CODELOCKS CONNECT PORTAL

All NetCode® locks are registered via the web-based Codelocks Connect Portal. Once registered, NetCodes can be generated and shared via email and SMS text message.** A built-in history provides an audit of all NetCodes created for each lock.

Additional Portal Features

Language

Choose from English and German. Language pack available for translation into other languages.

Associate Users

Add additional users to your account. These users can generate NetCodes for your locks.

NetCode® History

View the NetCodes created for every registered lock on the account.

Profile Management

Customise notifications and settings.

The Codelocks Connect Portal can be customised via CSS and custom logos added. For CSS customise, a hosting charge is applied. Please contact Codelocks to discuss these options.

API

Codelocks provide a simple API (application programming interface) to enable customers to generate NetCodes via their own applications. All standard NetCode® types can be created via the API. Prior to generating a NetCode®, the lock must be registered via the Codelocks Connect Portal. Please contact Codelocks to discuss these options.

TECHNICAL SPECIFICATIONS

FEATURE	DESCRIPTION
Operations	Up to 15,000 opening per 2 x 1.5 AAA batteries
Battery Override	A 9 volt PP3 battery can be placed against external contacts
Low Battery Warning	Red LED will flash on opening to indicate low battery
Functions	Private, Public and NetCode®
Buttons	11 individual round buttons
Material	Zinc Alloy
Finish Colour	Silver grey as standard
Door Thickness	Ready to fit doors up to 25mm (1")
Memory	Non-volatile memory will be retained
Fitting	Easy to install and program
Fitting Options	Vertical, right hand and left hand models
IP55 Rated	When used with rubber gasket (available separately)

Note: Not suitable for Chlorine environments.

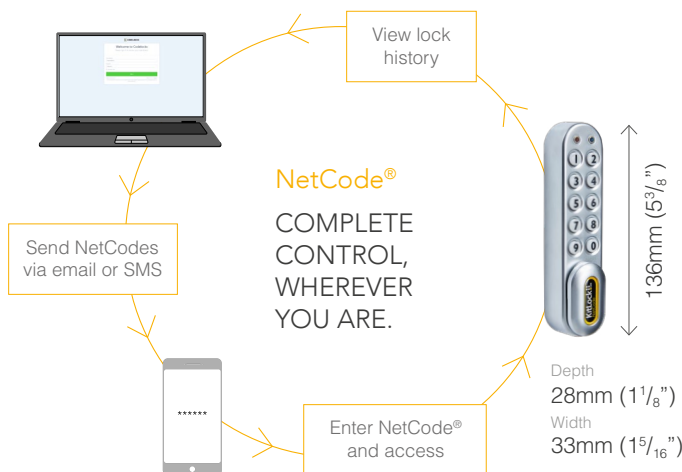



THIRD GENERATION NETCODE®



The KL1000 G3 NetCode® utilises technology that allows generation of date and time-sensitive, temporary access codes: NetCodes.

The updated chrome effect back panel and handle finishes reflect their surroundings giving the lock a slimmer, more subtle aesthetic. The KL1000 G3 NetCode® offers key override and front battery change capabilities providing ease of use and peace of mind. Sharing the same fittings & fixings as the KL1000 Classic, this lock is easily retrofitted, ideal for upgrading existing installations with increased flexibility and convenience for both guests and staff.



Easy to install
or retrofit



Key Override
capability



Front battery
change



Private and
Public Functions

FEATURES

- Date/time specific code generation
- Send generated codes via email or SMS**
- No WiFi connection required
- Easy install or retrofit
- Silver Chrome finish
- Master, Sub-Master, User and Technician Codes
- Up to 20 User Codes
- IP54 Rated when used with gasket (available separately)
- Two year guarantee*
- All parts / fixings / templates included

FUNCTIONS



Three Modes of Operation

The KL1000 G3 NetCode® retains the standard Public and Private Functions.

NetCode®

This function allows temporary access. Create date and time-sensitive codes via the Codelocks Connect Portal or your own application with our simple Application Programming Interface (API).

Private Function

This function is used where the same code will be repeatedly used. Choose a single four digit User Code to use multiple times. Ideal for use where the lock is allocated to a single person for a long period of time.

Public Function (default)

This function is used for short-term, multiple occupancy applications. Enter a four digit User Code to lock the locker, the same code is used to unlock. The lock remains open, ready for a new user and a new code.

TYPES OF NETCODE®

Four types of NetCode® are available:

- Short term multi-use codes with durations from 1 to 12 hours and 1 to 7 days
- Short term single-use codes with durations from 1 to 12 hours and 1 to 7 days
- Medium term codes with durations from 1 to 21 days
- Long term codes that work for periods of up to 1 year

ADDITIONAL NETCODE® FEATURES

Block Previous NetCode®

This feature automatically blocks the last used NetCode® when a new NetCode® is entered.

Mode Restrictions

Choose which types of NetCode® to support. This is a useful feature if the number of potentially available NetCodes needs to be reduced.

Block Specific NetCode®

Block a specific NetCode® directly on the lock using either the Master Code or another valid NetCode®.

Personal User Code

Allow a NetCode® user to create a personal 4 digit number that retains the same validity period as their originally allocated NetCode®.

API

Codelocks provide a simple Application Programming Interface (API) to enable customers to generate NetCodes via their own applications. All standard NetCode® types can be created via the API. Please contact Codelocks to discuss these options.



All NetCode® locks are registered via the online Codelocks Connect Portal. Once registered, NetCodes can be generated and shared via email and SMS*. A built-in history provides an audit of all NetCodes created for each lock.

Language

Choose from English and German. Language pack available for translations into other languages.

Associate Users

Add additional users to your account. These users can generate NetCodes for your locks.

TECHNICAL SPECIFICATIONS

FEATURE	DESCRIPTION
Codes	Master, Sub-Master, User and Technician Codes
Operations	Up to 100,000 operations per 2 x AAA batteries
Battery Override	A 9 volt PP3 battery can be placed against external contacts
Low Battery Warning	Red LED will flash on opening to indicate low battery
Functions	Private, Public and NetCode®
IP54 Rated	When used with gasket (available separately) IP55 available for special order
Cam	Cranked cam supplied (flat cam available separately)
Door Thickness	Ready to fit doors up to 19mm (3/4")
Spindle	Spindles to fit sheet metal doors and door thicknesses up to 25mm (1") available separately
Memory	Non-volatile memory will be retained
Fitting	Easy to install and program
Dimensions	136mm (5 3/8") H x 28mm (1 1/16") D x 33mm (1 5/16") W
Slam Latch	Retrofit to existing KL1000 G3 NetCode® locks or purchase for new locks (available separately)

Note: Not suitable for poolside lockers.

NetCode® History

View the NetCodes created for every registered lock on the account.

Profile Management

Customise notifications and settings.

STYLISH ENHANCED ACCESS



This stylish, standalone lock shares the same slimline design and powered latch as the KL1100 RFID but maintains the traditional code access keypad and features found in classic KitLock products.

The product enhancements make this a front runner for those looking for traditional standalone digital locks with additional User Codes and auto-unlocking capabilities. With up to 100,000 operations, 20 User Codes, Auto-Unlock at a set time or predefined period, this lock is an easy first choice for anybody looking to upgrade their lockers. Available in Metallic Silver or Gloss Black finish, the lock is easy to wipe clean with anti-bacterial wipes and sprays.



Battery
override



Easy wipe
clean



Private and
Public Functions



On the door
programming

FEATURES

- 8 digit Master and Sub-Master Code
- 20 User Codes
- 6 digit Technician Code
- Auto-Unlock at a set time
- Maximum locked period
- Battery override
- On the door battery change
- Powered latch
- Supports Private and Public Functions
- IP55 rated when fitted with gasket
- Anti-bacterial wipe clean
- Available in Metallic Silver or Gloss Black

FUNCTIONS



Private Function

This is the default function and is already pre-programmed in new locks. This is used where the same code will be repeatedly used, e.g. an employee with a personal locker/drawer.



Public Function

In this function the KitLock operates with a single User Code. The user enters a personal four digit code, this locks the lock. The same code is entered once only to open the lock and is automatically erased. The lock remains open ready for the next user. This function is used for short term, multiple occupancy applications.

BENEFITS

Auto-Unlock at a Set Time (Public)

Configure the lock to automatically unlock at a predefined time.

Maximum Locked Period (Public)

Configure the lock to automatically unlock after a predefined period.

Easy Installation

KitLock products are designed for easy install and the KL1100 KeyPad is no different, sharing the same fixing holes as the KitLock KL1000 Classic, retrofit is an option for many applications.

PRODUCT DIMENSIONS



Code Management

KL1100 KeyPad has four code levels available:

- 8 digit Master Code
- 8 digit Sub-Master Code
- 4 digit User Code
- 6 digit Technician Code

The KitLock is supplied with two factory set codes:

- Master Code
- User Code

Before installing, change the Master and User Code by following the Programming and Operating Instructions.



TECHNICAL SPECIFICATIONS

FEATURE	DESCRIPTION
Operations	Up to 100,000 operations
Low Battery Warning	Red LED will flash 3 times before unlocking
Power	Powered by 4 x 1.5 volt AA batteries (supplied)
Battery Override	Connect to 5V micro USB power source for temporary power
Door Thickness	Ready to fit doors up to 25mm (1")
Finish Colour	Metallic Silver or Gloss Black
Memory	Non-volatile memory - programming will be retained
Latch	Powered latch
Orientations	Vertical
Material	Mixed plastic and alloy
Functions	Public and Private
IP55 Rated	When used with gasket supplied

Note: Not suitable for Chlorine environments.



TAP LOCK GO

The KL1100 RFID lock features a stylish, slimline front plate giving any environment a modern, contemporary feel.

Choose between offline or cloud based software options to configure your locks and cards. The KL1100 is perfect for applications with a large quantity of lockers that would benefit from issuing and managing Card Clients from reception desks, for example, gyms, leisure centres, hospitals, hotels, schools and universities. The KL1100 is easy to install, operate and manage, featuring a powered latch enabling intuitive 'push shut' closing.



Easy to install



Remote Card Authorisation



Two year guarantee*



Private and Public Functions

FEATURES

- Master Card
- Technician Card
- Standalone Mode
- RCA Mode via offline or cloud based software
- Local management via plug-in programmer
- Date and time based features
- Powered latch
- Battery override
- Override code
- IP55 rated when fitted with gasket supplied
- MIFARE® Classic 1k compatible cards, fobs or wristbands can be used



STANDALONE MODE

Standalone Mode requires a Keypad Programmer (sold separately) for adding/removing cards and managing functions of the lock.

- Locally manage individual locks
- Supports Private and Public Functions
- Master Card
- Up to 50 User Cards per lock
- Up to 10 Technician Cards per lock

RCA MODE

Remote Card Authorisation (RCA) Mode offers remote management allowing Card Clients to be authorised via a PC using offline or cloud based software and a USB Card Reader.

- Manage individual or a group of locks
- Supports Private and Public Functions
- Up to 250 locks within a lock group
- Master Card and Technician Cards
- Multiple User Cards per lock

RCA OVERVIEW

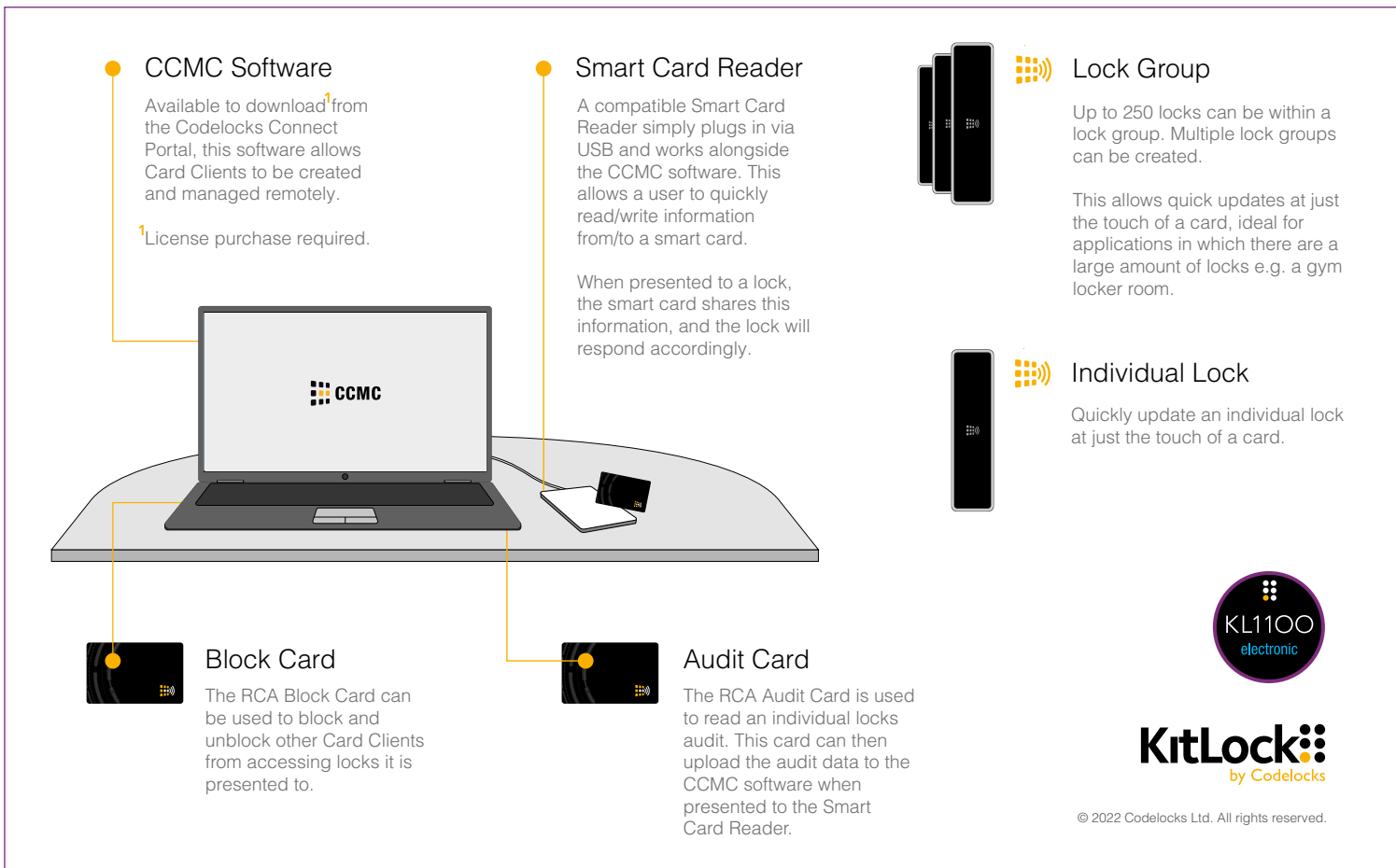



Remote Card Authorisation



MIFARE® compatible

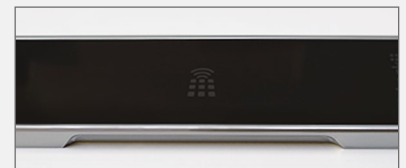

Stylish slimline profile



Powered latch



PRIVATE FUNCTION

This function is used where the same pre-registered User Cards are repeatedly used, auto-locking after each opening. Up to 50 individual User Cards, 10 individual Technician Cards and 1 Master Card can be registered per lock.



PUBLIC FUNCTION

The user presents a compatible card to an available open lock, this locks the lock and only that User Card, or a registered Technician/Master Card can be used to unlock the lock. The lock remains open ready for the next user. This function is used for short-term, multi-occupancy applications.

DIMENSIONS

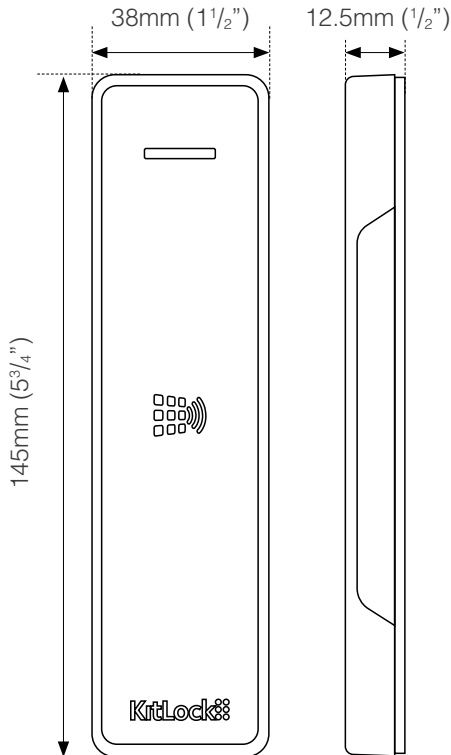

BENEFITS

Auto-Unlock at a Set Time (Public)

Configure the lock to automatically unlock at a predefined time.

Maximum Locked Period (Public)

Configure the lock to automatically unlock after a predefined period.

Dual Authorisation (Private)

This feature requires any 2 authorised Card Clients (either User or Technician) to be presented within 5 seconds of each other for the lock to unlock.

Override Code

A 4 digit code that allows emergency access in the event of the Master Card being unavailable. It is recommended an Override Code is created during set up. Programmer required.

TECHNICAL SPECIFICATION

FEATURE	DESCRIPTION
Operations	Up to 100,000 operations
Low Battery Warning	Red LED will flash 3 times before unlocking
Power	Powered by 4 x 1.5 volt AA batteries (supplied)
Battery Override	Connect to 5V micro USB power source for temporary power
Door Thickness	Ready to fit doors up to 25mm (1")
Finish Colour	Metallic Silver or Gloss Black
Memory	Non-volatile memory - programming will be retained
Latch	Powered latch
IP55 Rated	When used with gasket supplied
Card Client Types	Master, Technician, User, Initialisation, Block and Audit - Supports MIFARE® Classic 1k
Orientations	Vertical - Left Hand or Right Hand
Material	Mixed plastic and alloy
Functions	Public and Private



ROBUST KEYLESS ACCESS



For more challenging environments, the KL1200 includes all the benefits of the KL1000 but is tougher and more robust.

With additional programming features, stainless steel buttons, dual fixing points and increased battery life, the KL1200 provides enhanced benefits to facilities managers looking to simplify access control without the need for keys. Quick, tough and cost effective.



Easy to install



On the door programming



Two year guarantee*



Private and Public Functions

FEATURES

- 11 button keypad
- 8 digit Master and Sub-Master Code
- 4 digit User Code
- 6 digit Technician Code
- Right hand version available
- Up to 50,000 operations from 2 x AAA batteries (supplied)
- Battery override
- Auto unlock feature
- Audible keypad
- Slam latch accessory available
- IP54 rated when fitted with gasket
- All parts / fixings / templates included

FUNCTIONS



Private Function

This is the default function and is already pre-programmed in new locks. This function is used where the same code will be repeatedly used, e.g. an employee with the same locker/drawer in the workplace.



Public Function

In this function the KitLock operates with a single User Code. The user enters a personal four digit code, this locks the lock. The same code is entered once only to open the lock before automatically being erased and ready for the next user. This function is used for short term, multiple occupancy applications, e.g. hot desking in an office or a locker in a sports club.

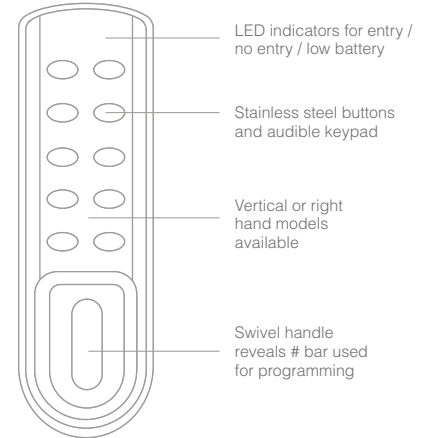

PRODUCT DIMENSIONS



Code Management

KL1200 has four code levels available:

- 8 digit Master Code
- 8 digit Sub-Master Code
- 4 digit User Code
- 6 digit Technician Code

The KitLock is supplied with two factory set codes:

- Master Code
- User Code

Before installing change the Master and User Code by following the Programming and Operating Instructions.

Easy Installation

Everything you need is included to ensure a quick and easy installation.

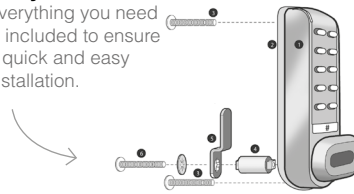

TECHNICAL SPECIFICATIONS

FEATURE	DESCRIPTION
Operations	Up to 50,000 opening per 2 x 1.5 AAA batteries
Battery Override	A 9 volt PP3 battery can be placed against external contacts
Low Battery Warning	Red LED will flash on opening to indicate low battery
Functions	Private and Public
Buttons	11 individual round buttons
Material	Zinc Alloy
Finish Colour	Silver grey as standard
Door Thickness	Ready to fit doors up to 25mm (1")
Memory	Non-volatile memory will be retained
Fitting	Easy to install and program
Fitting Options	Vertical and right hand models
IP54 Rated	When used with rubber gasket (available separately)
Slam Latch	Separate accessory - allows 'push shut' locking of the door

Note: Not suitable for Chlorine environments.



Go Keyless. Go KitLock.

“The KitLock solution is more professional and, from a guest perspective, the lockers are now far more secure as keys are not left lying around in robe pockets. It’s a smarter way to control the lockers as the guests are responsible for using the lockers and selecting their own codes.”

- Champneys Health Spa Resort





1

2

3

4

5

6

7

8

9

0

*

#

CODELOCKS

SIMPLE DOOR CONTROL



Introducing the A3 range from Access by Codelocks. Compact, standalone programmable door controllers with RFID functionality.

The A3 range includes three compact standalone door control models suitable for internal and external applications. For use with magnetic locks and electric strikes, the range provides proximity access for up to 1000 users. Eliminate the hassle of missing keys and doors being left unlocked all day. The A3 range of door controllers offer a keyless solution as a standalone product; an affordable access control system that does not require complex software purchases, external programmers or licensing costs.



Single door
control



Internal &
external use



Two year
guarantee*



Smart card &
fob access

FEATURES

- Three models available
- MIFARE® compatible
- Master Programming Cards included
- Configurable penalty time
- Anti-tamper sensor
- LED status indicators and backlit keypad
- Flush or surface mount options
- Alarm and doorbell connections
- Card, Code and Panic Clients
- Fixings / templates included
- Conforms to IP66

 **Access**
by Codelocks

MODELS



A3 RFID
RFID MIFARE® compatible door controller. Provides proximity access for up to 1000 Card Clients. Can be flush or surface mounted.



A3 DUAL
Surface mounted RFID MIFARE® compatible door controller with keypad. Provides proximity access for up to 600 Code/Card Clients, including two Panic Clients. Advanced functions and access modes available.



A3 VANDAL RESIST
Heavy duty RFID MIFARE® compatible with keypad and doorbell connections. Provides proximity access for up to 600 Code/Card Clients, including two Panic Clients. Advanced functions and access modes available.

FUNCTIONS

Configurable Relay

ALL MODELS

Pulse Mode allows an adjustable re-lock time to be set between 1-99s (5s default).

Latch Mode enables passage functionality allowing Code or Card Client free access.

Multiple Access Modes

A3 DUAL & A3 VANDAL RESIST

Dual Authorisation requires a valid Code and Card Client to be presented in order to allow access.

Reader Mode where the unit acts as a Wiegand¹ reader linked to another unit.

Penalty Time

ALL MODELS

Presenting an incorrect Card or Code Client 10 times will incur a 30 second time delay before any further use is possible.

Door Interlock

A3 DUAL & A3 VANDAL RESIST

Sometimes referred to as a 'Door Airlock' system, this function allows two door controllers to be linked. For example, the first door will require closing before the second door can be opened.

TECHNICAL SPECIFICATIONS

		A3 RFID	A3 DUAL	A3 VANDAL RESIST
Clients	Compatible With	13.56MHz MIFARE® (ISO 14443 Type A)	13.56MHz MIFARE® (ISO 14443 Type A) & 125KHz	13.56MHz MIFARE® (ISO 14443 Type A) & 125KHz
	Max. Capacity	Up to 1000	Up to 600	Up to 600
Operation	Voltage	12-24V DC	12-18V DC	12-28V DC
	Idle Current	20mA	35mA	65mA
	Working Current	80mA	100mA	100mA
	Inputs/Outputs	Relay, Push-to-Exit	Relay, Push-to-Exit, Alarm, Door Contact, Wiegand Input, Wiegand Output	Relay, Push-to-Exit, Alarm, Door Contact, Wiegand Input, Wiegand Output
	Wiegand ¹	-	Input/Output: 26-37 bits PIN Output: 4 bits, 8 bits (ASCII), 10 Digits Virtual Number	Input/Output: 26-37 bits PIN Output: 4 bits, 8 bits (ASCII), 10 Digits Virtual Number (4 bits default)
	Read Range	60mm (2 ³ / ₈ "	60mm (2 ³ / ₈ "	60mm (2 ³ / ₈ "
Environment	IP66 Rating	✓	✓	✓
	Temperature	-30°C ~ 60°C (-22°F ~ 140°F)	-40°C ~ 60°C (-40°F ~ 140°F)	-40°C ~ 60°C (-40°F ~ 140°F)
	Humidity	10%RH ~ 98%RH	10%RH ~ 98%RH	10%RH ~ 98%RH
Dimensions	External (W x H x D)	48mm x 102.5mm x 17mm (2" x 4 ¹ / ₁₆ " x 5/ ₈ "	49.5mm x 123mm x 22mm (2" x 4 ⁷ / ₈ " x 7/ ₈ "	50.5mm x 150mm x 20.5mm (2" x 5 ⁷ / ₈ " x 3/ ₄ "

Note: Not suitable for Chlorine environments.

¹ Wiegand is a wiring standard used in access control systems. When a unit acts as a Wiegand reader, it can be used to connect devices together.

MIFARE® is a registered trademark of NXP B.V.



case studies

A word cloud featuring various business and service categories. The words are arranged in a roughly rectangular shape, with some words being significantly larger than others. The largest words are 'offices', 'hotels', 'leisure centres', 'transport', 'gymnasiums', and 'spas'. Other prominent words include 'Royal Mail', 'banks', 'hospitals', 'government', 'architects', 'retail stores', 'stadiums', 'golf clubs', 'universities', 'schools', 'construction', 'warehouses', 'financial institutions', 'data', 'centres', 'utility companies', 'logistic companies', 'football clubs', 'holidays', 'parks', 'facilities and property management', 'charitable groups', 'trusts', 'B&Bs', 'rental apartments', 'GP centres', 'care homes', 'nurseries', 'colleges', and 'local authorities'. The words are in various orientations, including horizontal, vertical, and slightly rotated.

warehouses
financial institutions
data
centres utility companies
banks
transport
logistic companies
Royal Mail
golf clubs
gymnasiums
universities colleges
schools
spas
football clubs
construction
nurseries
holidays
parks
facilities and property management
offices
care homes
B&Bs
stadiums
trusts
charitable groups
hospitals
GP centres
government
rental apartments
local authorities
architects
retail stores



KitLock raises the bar for new work and wellbeing facilities

Family-owned and run architectural ironmongery, G Johns, has been in business for over 125 years. Part of its long-standing service is supporting clients with refurbishment and restoration projects. When G Johns was asked to supply a locker lock solution for a new gym and changing facilities as part of a client's office refurbishment, the company called on Codelocks for help.

Building a healthier workspace

G Johns was working with Sopers House, to renovate its offices and create a more productive, modern and convenient coworking space for

employees, visitors and members. The renovation project involved adding a gym to encourage a healthier working environment and with it changing rooms with lockers.

"In any office-based job, day-to-day work can involve a lot of sitting down and screentime so it's valuable to offer our coworkers a space where they can exercise and boost their physical and mental well-being."

To prioritise ease of use and avoid workers having to carry a padlock or key, Sopers House didn't want the coin- or key- and padlock-operated lockers that are typically found in gym changing rooms. Discussing its options with G Johns, Sopers House outlined that its ideal solution would:

- be keyless
- be easy to operate and manage

- offer a key override function in case a worker left their belongings behind
- match the aesthetic of the office upgrade

Simplicity from installation to use

Jeremy Baltrop, Director at G Johns, was confident that Codelocks would be able to provide the access control solution to meet Sopers House's needs. Jeremy explained, "Codelocks were my first choice for a couple of reasons. We've collaborated with Codelocks on a number of projects over the last 20 years so there's already a strong and trusted professional relationship there. Plus, I recently attended one of Codelocks' ▶

Continuing Professional Development events on locker locks which was incredibly engaging and informative.

When Sopers House brought up the need for a locker access control solution, I was already armed with information on the benefits and features of Codelocks' various KitLock locks. I knew the KL1000 G3 was right option to suggest."

The KL1000 G3 is a popular lock in the KitLock by Codelocks range. It is a neat digital lock with key override and front battery capabilities, making it easy to use and operate.

Retrofitting the KL1000 G3 onto Sopers House's existing lockers was a simple process. It takes minutes to remove the existing cam lock and make an additional top fitting. The lock comes in Black Chrome which provided a perfect match for the sophisticated and modern aesthetic that Sopers House wanted for its office and gym upgrade.

Synonymous with quality

With 250 Codelocks' KL1000 G3 locks installed on to the lockers, workers and members actively benefit from the new gym facilities and having a space to store their belongings. The KL1000 G3 has delivered a solution that is uncomplicated for Sopers House's facilities manager and gym goers.

Jeremy said, "Not having to use keys to access the lockers is a gamechanger. The KL1000 G3 is largely effortless for the facilities manager to oversee, so

they can spend their time on higher priority tasks. The new locks have helped make the gym experience as streamlined as possible as workers and members can simply access the lockers using a code."

Commenting on G John's ongoing partnership with Codelocks, Jeremy added, "In terms of the Codelocks experience, one of the big things that draws us back is the quality of the products. Codelocks is a bit like the Hoover of digital and mechanical locks – its name is synonymous with quality.

"With our clients increasingly concerned about the environmental implications and life span of the products they buy; we feel confident recommending Codelocks because we know its products will last.

"Plus, Codelocks deliver excellent backup from its customer service team. Whether that's at the initial inquiry, at professional training events or with aftercare - Codelocks really are with you for the whole journey."





Product innovation fit for luxury spa

Award-winning chain of health spa resorts and luxury hotels, Champneys, aims to provide a relaxing oasis for its customers away from the chaos of day-to-day life. It offers treatment packages and a blend of luxury health and fitness breaks. Each resort is equipped with a gym, swimming pool, sauna and steam room.

Time for an upgrade

Champneys Tring is Britain's original health spa and since 2012 has had Codelocks' KL1200 installed for the locks in its locker rooms.

While the KL200 has stood the test of time and reliability, after a decade of frequent

use, Champneys Tring's Maintenance Manager, Karl Johnsen, had noticed some wear to the lock cams. This was likely caused when people accidentally closed the locker door while in locked position opposed to open.

In a period of 10 years, Champneys' style and aesthetic has also evolved. Karl sought a cleaner, more sophisticated locker lock to fit the sleek and modern décor expected of a luxury spa.

Having already established a longstanding relationship, Karl trusted Codelocks for an upgrade.

Simple, stylish access

As guests are coming and going, Champneys needed to maintain the element of temporary access control. With spa guests often in robes and without bags, it wanted to ensure a keyless solution to avoid the risk of losing keys and

the cost of maintaining keys, as well as guaranteeing convenience for its clients. The KL1100 KeyPad was the perfect choice.

Karl Johnsen, Maintenance Manager, Champneys Tring said, "Having already experienced 10 years of quality locker locks and its excellent customer service, KitLock by Codelocks was the obvious choice when I required an upgrade at our Champneys Tring branch. The KL1100 KeyPad offers simple, stylish access to locker storage for our guests and have added to the refreshed, modern aesthetic that our clients expect at a luxury spa." ▶

“Codelocks and the locksmith specialist made the transition to the new locks as seamless as possible.”

Codelocks partnered with J.Priest & Family, a reliable locksmith specialist, to install the 220 new locks onto the lockers. Having collaborated together on a previous project J. Priest & Family was an obvious recommendation to fit the KL1100 KeyPad. The locksmith also provided custom plates with locker numbers when retrofitting the locks. These matched the aesthetic of the lock and offered a practical solution to easily identify a customer's locker.

10 years of innovation

“At Codelocks, we are always striving to advance our products to give an improved experience for our customers. After 10 years of innovation, our KitLock by Codelocks range has developed offering the latest technology and with it, more sophisticated, simple, and stylish access control for lockers and cabinets,” explained Steve Newman, KitLock Sales Manager at Codelocks.

After a decade, there were a number of new features in the KitLock by Codelocks range that Champneys Tring could take advantage of.

The KL1100 KeyPad can automatically unlock after a set period of time, for example in the middle of the night when the locks aren't in use. This is useful for Champneys because it helps with access for cleaning and also reduces locker hogging and the need for lockers to be manually unlocked and

checked at the start of every day, saving considerable time.

Another new feature is that the KL1100 KeyPad is equipped with a battery-powered slam latch, eliminating the risk of damaging the cam.

Whereas the KL1200 had required the locks to be removed from the door to change the battery, the KL1100 KeyPad has a cover on the latch which slides up. This allows battery changes to be made quickly and with ease while the locks are still attached to the locker door.

Codelocks has also been refining the aesthetic of its range of cabinet locks to evolve with changing styles. The KL1100 KeyPad's sleek and slimline design is easy to wipe clean and compliments the luxurious and modern look of modern-day spas.

Karl said, “We're really pleased with the KL1100 KeyPad. When coming to Champneys Tring for a peaceful getaway, customers don't need to worry about keys and can enjoy the spa in comfort, knowing that their belongings are stored conveniently and safely.”





Codelocks facilitates future of flexible working

With organisations adopting a hybrid working model and moving towards flexible working also comes a need for flexible office solutions. International office and workplace solutions provider Kinnarps, approached Codelocks as it was looking to furnish a UK county council with an access control solution suitable for its hybrid working needs.

Flexible working hubs

The UK county council has adopted a hybrid working model to best suit the needs and lifestyles of its employees. The council has multiple working hubs across the country, allowing its teams to choose

the office space that is convenient and accessible to them on their chosen office days. However, despite not being tied to a specific location, the need for employees to store possessions in the workplace remains.

The council sought a storage solution that:

- can be used on temporary basis
- is easy to manage
- is within its constrained budget
- accessed by different people on different days, for varying time periods

Perfect partnership

Due to its longstanding relationship with Codelocks, Kinnarps is familiar with the wide range of KitLock by Codelocks cabinet and locker locks.

Steve Newman, KitLock Sales Manager at Codelocks explains, “We understood the council wanted to avoid the need to cut

keys or have lockers allocated to specific employees. And with the ongoing concern of COVID-19 and the transfer of germs, it was also important to give easy access to personal belongings whilst minimising touch. The KL1100 RFID offers the flexibility the council needs.”

The KL1100 RFID is a smart card operated lock designed for both public and private lockers. It is perfect for building and facilities managers that oversee large quantities of lockers, as they can benefit from managing cards remotely.

Kinnarps found a locker company that the KL1100 RFID could be installed on and ▶

combined the two products to create 'hot lockers', similar to hot desks for all of the county council offices. County council employees simply collect a card from the reception at the start of their day, use a dedicated locker to store their personal belongings, and then return the card so it can be used by someone else the next day.

Simon Cotter, Account Manager at Kinnarps said, "We needed to provide over 1000 lockers for the council, so we sought a supplier that had an innovative and stylish lock solution with enough available stock. Due to the volume of lockers we needed to provide, we were glad that the KL1100 RFID was straightforward to install."

Convenient contactless access

The KL1100 RFID is perfect for the council's hybrid-working approach. "The council office manager has expressed the importance of being able to manage card access remotely, as their employees are all working on different days and at different times. It also removes the cost and hassle of having to cut and hand out keys." explains Simon.

"Council employees have found the lockers easy to operate and appreciate the fact the council has put a storage solution in place that is secure and requires minimal contact."

Council employees can now be sure that whichever office they choose to work from, they have convenient access to lockers to store their belongings.





CodeLocks creates perfect balance for London's leading yoga and Pilates provider

triyoga were looking for modern, simple and secure lockers that were hassle-free for members to use. CodeLocks provided the solution with the KitLock KL1000 lock, a robust, easy to use electronic locking system specifically designed to provide keyless and coinless access.

Founded in 2000, triyoga has become London's top destination for yoga, Pilates and treatments. With established centres in Camden, Chelsea, Covent Garden, Ealing and Soho, the latest addition in Shoreditch offers over 125 yoga, Pilates and barre classes per week. Each centre has been designed to create a calm, relaxing and rejuvenating space amongst London's bustle.

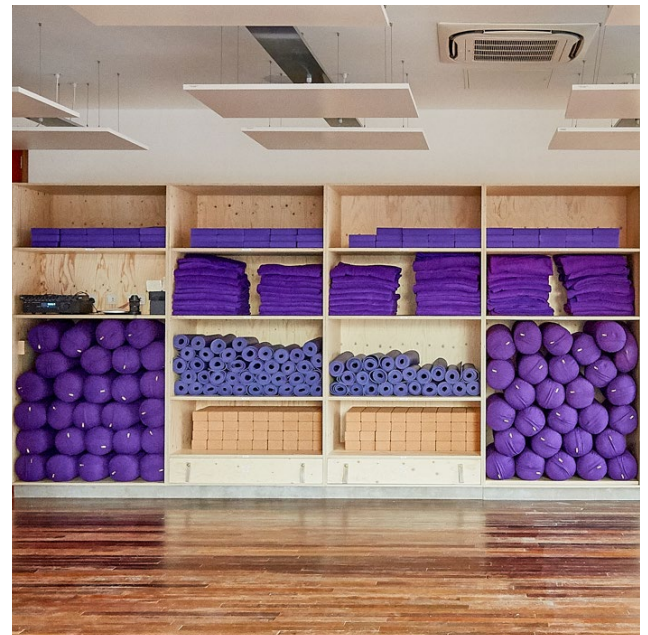

PEACE OF MIND

Before KitLock locker locks were installed, triyoga guests used coin operated key locks. This meant guests had to take their locker key with them to treatments and classes, often misplacing them. For triyoga staff, managing locker keys became problematic and extremely labour intensive. This prompted them to search for a lock that looked modern, was simple to operate and secure.

A FLEXIBLE SOLUTION

Following a recommendation from a locker manufacturer, triyoga specified the KitLock to the designers of the new Shoreditch centre, Aldworth James & Bond.

James Cannon, facilities manager at triyoga immediately knew they were the perfect match. "The KitLock from Codelocks ticked all the boxes, from price point to functionality and had clearly been designed with ease of use in mind. I immediately contacted Aldworth James & Bond who procured 150 of the KL1000 locks."

**Aldworth James
& Bond**



Dan Benson, project manager at Aldworth James & Bond explained, "The most important requirement for triyoga was that users didn't need keys."

"The KL1000 was the perfect solution for triyoga, and from start to finish the service we received from Codelocks was brilliant, we've really enjoyed working with them. Procurement was easy, installation was straightforward and we received great customer service."

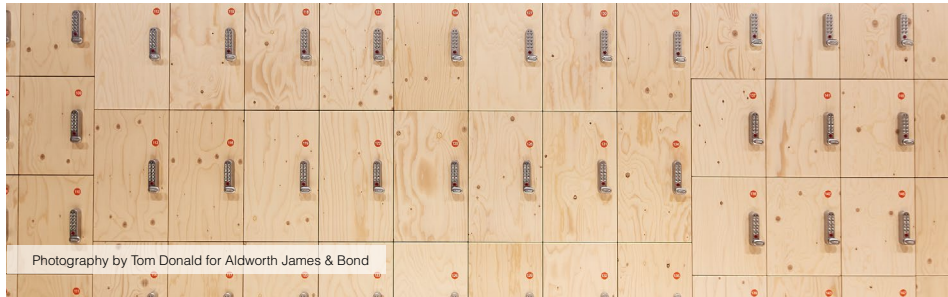

KITLOCK EXPLAINED

The KitLock KL1000 is a digital cabinet lock ideal for replacing padlock locker mechanisms and traditional key cam locks supplied at many gyms, spas and leisure centres. It uses a four-digit code rather than a key to operate and secure the locker. In Public Function guests simply enter a code, "lock and go". When it's time to leave, the customer enters their code again and the locker opens. The code is then automatically erased, leaving the locker free for the next customer.

THE GURU OF LOCKER LOCKS

To ensure an environment of peace and tranquillity, members can now enjoy a stress-free experience without the inconvenience of carrying locker keys and coins. triyoga have programmed the locks in Public Function, allowing members to easily find a locker, whilst

allowing staff members access at the end of the day for cleaning.

"The KitLock solution is user-friendly, secure and takes the duty of care away from us as keys are no longer left lying around," said James.

"Features such as the technician code are extremely useful when a customer forgets their code, plus we are able to open all the lockers at the end of the day and check nothing is left inside overnight.

"We designed our centres to be slick, beautiful and at the top of their game, whilst also offering comfort and convenience. The KitLock from Codelocks has allowed us to ensure that this aesthetic goes beyond the studios and treatment rooms and into the changing rooms, much more in keeping with the quality expected from our centres."



Codelocks enables Parks Tennis to offer 'pay and play' access to tennis courts

Parks Tennis was searching for the best way to manage access to its public tennis courts. The goal was to secure the courts making it easy to book and use them, whilst generating income. Codelocks enabled a simple 'pay as you play' solution with the CL5510 smart lock. This lock gives the ability to create and send codes remotely to customers, simplifying Parks Tennis' booking procedure and ensuring the courts remain protected and profitable.

CONTROLLING ACCESS TO PUBLIC TENNIS COURTS

Previously, the tennis courts could be booked online, but many people just turned up and began playing. This meant that there was no control over when the courts would be available, and

paying customers would turn up and be disappointed. People were also able to use the courts without paying, resulting in lost income. Oxford Council were concerned that the open access combined with loss of income would cause the tennis courts to fall into a state of disrepair. There was a need for the courts to be managed in a new way to ensure the tennis courts could be maintained, and the community a safe environment locally to play tennis.

CODELOCKS SERVES AN ACE

Parks Tennis wanted to make it simple for people to book the tennis courts for specific timeslots. A year was spent researching the market; many potential solutions were considered before being dismissed. Mechanical and fob locks involved too much administrative hassle; padlock combination

locks were not robust enough for the outdoor environment and heavy usage. Many digital locks were prohibitively expensive, or needed to be part of a complex wired-in system. Codelocks offered the solution to these problems. Its coded locks are keyless, robust, excellent value, and battery powered. Sometimes it's more cost effective to look at a standalone solution, and this is where the use of digital door locks can provide many advantages.



Parks Tennis chose the CL5510 smart lock for its ability to generate unique access codes remotely, offering convenience for players and coaches. Customers can now book a timeslot through the website and automatically receive a unique code via text or email, which allows them access to the courts during their specified timeslot. The codes are 'disposable,' expiring after a set time. Customers therefore know that the courts will be available to use at the time they have booked. This simple 'pay and play' solution was made possible due to the CL5510's smart capabilities.

GAME, SET AND MATCH

For customers, it is now easy to book and access the courts at a time convenient to them. Time-specific access has resulted in a fairer solution for the community, removing the problem of 'court hogging.' For coaches, it is easy to access the courts ahead of their sessions to set up and get ready for players. The Council are no longer concerned about court maintenance, which was under threat from government-imposed budget cuts. Since installing Codelocks' CL5510 smart lock, income from the courts has doubled. Funds raised help to maintain and safeguard the courts.

It is a more manageable solution for Parks Tennis staff, as it removes the need for them to be onsite. Administrative time and

costs are now kept to a minimum as time is no longer spent changing the lock codes or issuing and retrieving keys. Through the CL5510 Audit Trail function, Parks Tennis can gather customer data to gain insight into the use of the courts. This helps to inform decision-making and encourage repeat bookings.

“A good value, cleverly-designed lock”

FROM THE MANAGING DIRECTOR

“The CL5510 was exactly what we were looking for: a good value, cleverly-designed lock which enables time-sensitive access codes to be issued automatically. The lock is easy to use, cost-effective, and battery powered, requiring no internet or electricity to install. It works seamlessly with our existing booking systems. Codelocks are also a fantastic partner to work with; they are always available and they offer first-class support. What we particularly like about the CL5510



is that it can generate codes hour by hour, day by day; the codes are unique every time. It can also be preloaded with several four-digit pins, which is useful for people who use the facilities regularly, such as tennis coaches. On top of that, we can issue smart cards to stakeholders, such as tennis clubs or Parks Wardens, for 24/7 access. So, one single product has helped us meet the needs of all the different stakeholders. It has allowed us to make low-cost community sport available and accessible to all.” Jeff Hunter, MD Parks Tennis CIC

ABOUT PARKS TENNIS

Parks Tennis is a not-for-profit community interest company: its mission is to improve lives through tennis. It organises community coaching programs and 'pay and play' programs in parks. It also offers social tennis sessions for different age groups and different playing standards, with the aim of engaging entire communities.

It has taken around 40,000 bookings on tennis courts and coaching programs in the last 18 months; it currently has over 12,000 customers enjoying tennis across the UK.

CODE.



CARD.



PHONE.





Codelocks supplies harmonious self-service solution for Pirate Studios

Pirate Studios is a start-up company offering bands and musicians a new way to rehearse. Rather than expensive hourly hires, its self-service studios are available to hire at allotted times, 24/7. Things are kept as simple as possible, with instant online booking and on-site storage for equipment. It has studios in Birmingham and Bristol, with a new studio in Cardiff nearing completion and further sites in the pipeline. Codelocks provided the solution with the CL5510 smart lock, which enables time-specific codes to be created via an online portal and sent remotely via SMS or email.

ACCESS CONTROL TO SELF-SERVICE STUDIOS

Pirate Studios were searching for a way that customers could let themselves in and out of the studio unaided. This was of the utmost importance to the business

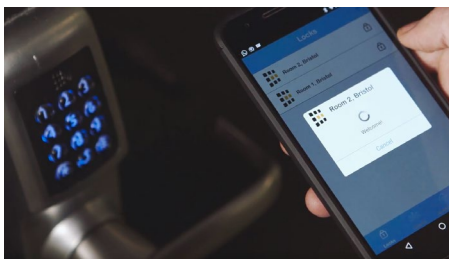

model, as eliminating the need for staff onsite would allow it to keep overheads and rental prices down, passing on the benefit to its customers.

Smart locks with key code entry and advanced programming functions turned out to be the solution. Pirate Studios are now able to issue customers with time-limited access codes for studio rental and storage lockers. The codes can be sent remotely and automatically expire after a set duration.

IN TUNE WITH CONVENIENCE

Codelocks fitted CL5510 smart locks on the front door and individual studio room doors, and KitLock locker locks on the storage for music equipment. These locks allow codes to be created via an online portal and issued to customers via email or SMS. This eliminates the need for staff to be onsite. Musicians receive personalised codes for self-service access to the rehearsal space and / or storage lockers.

Unique codes can be issued for different locks. So, for example, if a musician needed to access their kit, but not a rehearsal space, they would be given two codes: one for the front door and one for storage. Or, for studio room hires, musicians would be given a code for the front door and one for an individual studio door. Codelocks' smart locks increase convenience and decrease prices for Pirate Studios' customers.

The CL5500 range uses 'disposable' time-specific codes, that expire after a set duration. This, combined with the Audit Trail function, ensures that Pirate Studios can track which users are going in and out of the rooms, and at what time. The K3 App allows the locks to be monitored via a smartphone, as well as offering additional functionality in terms of opening the lock with wireless connectivity.

SMART LOCKS

With the CL5500 range, controlling access has never been so convenient, especially since all aspects of the locks can be managed remotely using a smartphone. Users can choose the most suitable entry method for their needs, whether allowing access via a simple code or by the use of compatible smart cards. The lock audit trail data can be downloaded and viewed, to keep track of when and where the lock was accessed. Codes can be set for a specific start date and time, automatically expiring after a set duration. 'Code free' periods can be set to allow free access at certain times of day.

THE PERFECT FIT

Pirate Studios searched worldwide to find locks that were suitable for their demands, and discovered that Codelocks offered the best solution. They initially contacted Codelocks to ask for their expert advice about NetCodes. Codelocks were able to explain how NetCodes worked, and how this function could work as a perfect duet with Pirate Studios' existing API system to allow studio booking and locker rentals. Codelocks introduced specific lock options, allowing Pirate Studios to opt for different locks to suit different functions, not only for the individual studio rooms and lockers, but also for their front door access to the studios.



“ We were very lucky in finding Codelocks when we did. We had a big requirement for codes that were specific for a time period, in order to make sure our security was tight. We searched high and wide across the globe for a lock that would do that for us, and the Codelocks NetCode® was perfect for our requirements. Not only did it provide the functionality we needed, but also a very easy to use back-end that we were able to communicate with easily. ”

David Borrie, co-founder of Pirate Studios

CODE.



CARD.

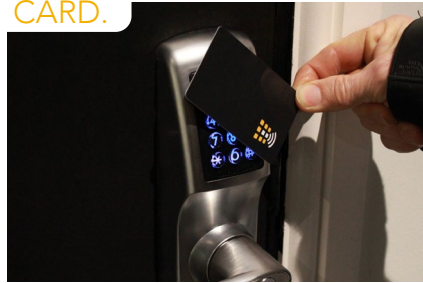

PHONE.

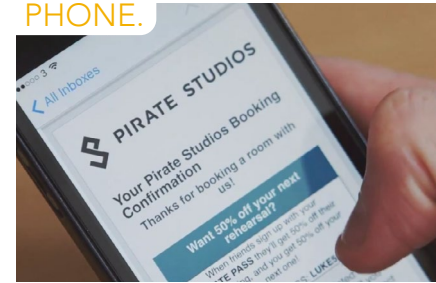



Digital door locks control contractor access at University Hospital Southampton

Access control products are widely used within hospital buildings to enhance the safety and security of the people and equipment inside. For the locksmiths working in the estates building maintenance department at University Hospital Southampton, access control is a high priority. Supervisors, Eamonn Devaney and Ron Bran, and their team* need to control the movement of thousands of people on campus and keep the hospital running efficiently at the same time. With over 9,500 employees and a large transient population visiting the hospital daily, this is no easy task.

To help deter unauthorised entry to restricted areas, the estates building maintenance team use a combination of access control products including locks and keys, hard-wired systems requiring RFID cards and readers, as



well as standalone mechanical and electronic digital locks. Working together, the products help create a physical barrier, while at same time allowing authorised personnel to go about their daily routine.

MANAGING KEYS AND CARDS

Managing room keys and access cards for hard-wired systems on a large scale can be problematic. With such high numbers of staff working at the hospital, it's inevitable that some will get lost or stolen. The time taken to manage the issue of new and replacement

cards can be considerable, but it's essential in order to maintain security.

Because cost is such an important factor when considering which access control products to use for new buildings or refurbishments, it's not always possible to extend the use of hard-wired systems throughout campus.

Sometimes it's more cost effective to look at a standalone solution, and this is where the use of digital door locks can provide many advantages.



Digital locks can be installed one door at a time without impacting other systems. There are no keys or cards to issue; instead staff members are given an access code to get through the door.

Access codes can be changed on a regular basis to help prevent codes from being passed on or misused. Digital locks are either mechanically or electronically operated. The estates building maintenance team use hundreds of mechanical and electronic door locks all over campus to give access protection to areas such as treatment rooms, offices and laboratories.

The main advantage of electronic door locks over their mechanical counterparts is their ability to provide more functions.

With electronic digital locks, more code combinations are available, the locks will shut down temporarily after three incorrect code attempts and code changes can be made via the keypad. Now, thanks to developments in technology, some electronic door locks facilitate PC-based programme control and audit trail. Where previously only card-based access control systems could provide this functionality, the doors to new applications for this product are wide open.



A good example of this is at the University Hospital Southampton, where the estates building maintenance team is trialling the use of eight new digital electronic locks with audit trail from Codelocks.

One of the challenges the team faces is the ability to protect vital supplies, equipment and machinery needed to keep the hospital operating efficiently. Access protection is needed to deter theft and damage to property, both of which disrupt the smooth running of the hospital.

The hospital employs different contractors to manage the building's services, and the contractors' engineers need regular access to rooms containing plant and machinery.

Using the Codelocks CL5010 tubular mortice latch locks with audit trail and accompanying software, the team can allocate individual time-sensitive access codes to plant room doors. The codes will only work for the hours the engineer is contracted; they will not work outside this timeslot.

Since the installation of Codelocks at University Hospital Southampton, it has worked very well and everyone is happy with the functionality the product provides. Supervisor, Eamonn Devaney commented: "All of the experienced locksmiths working on the team have found the product to be very user friendly and easy to maintain. It's also great knowing that Codelocks is on hand to provide additional support if necessary". Unlike other access control systems this product requires no hard wiring, cutting down on installation costs and causing very little disruption.

As technology continues to enable improvements in the performance and capability of electronic digital door locks, the breadth of their application will expand and enable them to claim an even greater share of the access control market.

*The estates building maintenance team at University Hospital Southampton consists of supervisors, Eamonn Devaney and Ron Bran, carpenter/locksmith and lock maintainer, Richard Fenton, and carpenters/locksmiths, Simon Priestly and Gerry Whittaker.



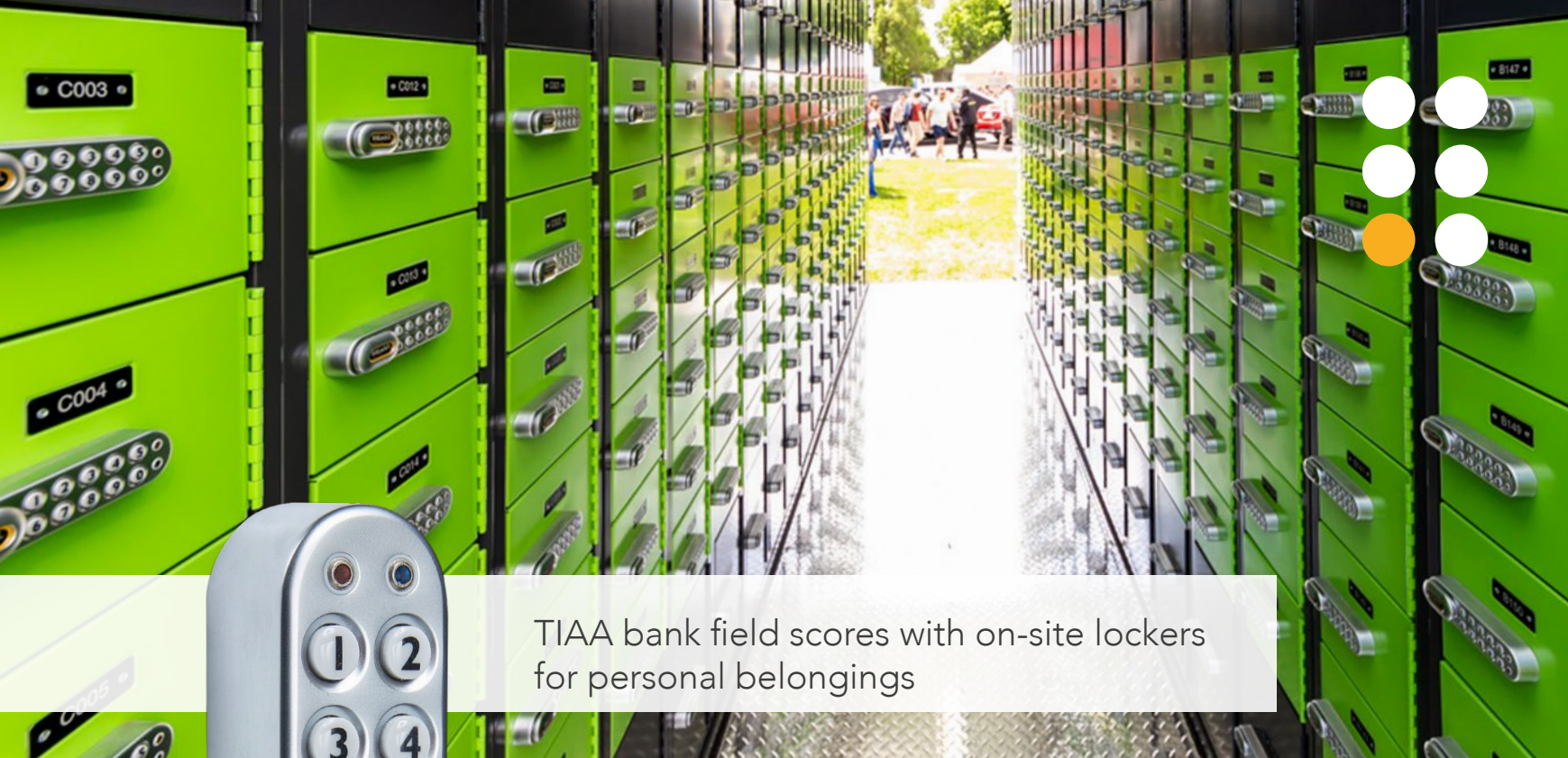

TIAA bank field scores with on-site lockers for personal belongings

Stadium bag policies continue to be a growing priority at sports stadiums and arenas all around the United States with regard to personal bag size and the particular items that are permitted into facilities during scheduled events.

Initially implemented for the 2013 professional football season, the National Football League (NFL) launched a new bag policy intending to provide a safer environment for the public and to expedite fan entry.

CHALLENGE ON THE FIELD

If not adhering to the NFL's bag policy, an entire day-out experience can potentially be ruined for fans; thus, individuals and sometimes entire families are restricted from entering the stadium.

In 2013, when the first policy was enforced, TIAA Bank Field, home to the

Jacksonville Jaguars, set up an area to replicate a coat check, which included rolling racks. Game day attendees would have a place to bring their restricted items – briefcases, purses, etc. – and, in turn, would receive a numbered ticket to retrieve their item at the conclusion of the game. This was beneficial to attendees using the service; however, ticketing many items per game was a labor-intensive process for the stadium. "This old school approach wasn't working for us. What we really needed was something automated, self-sufficient and easily implemented," said Ryan Prep, Director of Facility Operations, Jacksonville Jaguars.

THE PERFECT SOLUTION

What started as an empty shipping container with lockers, evolved into a solution that would solve Prep's

needs for a secure way to store attendees' belongings. "We created the LOKnCHARGE lockers after noticing the frustration from individuals who attend events and have no place to put their items," said Benoit Briere, CEO of LOKnCHARGE, a Montreal-based secure mobile locker solution. "There was a need for security and convenience, so I was on the hunt for a secure, yet simple solution to ensure each locker can be locked by the individual using it," continue Briere.

After researching solutions, Briere found Codelocks, an access control company that specializes in standalone keyless door locks and access products. These two companies teamed up to develop a secure, on-site alternative for attendees of not only sporting events, but music concerts and street festivals to enjoy their event unencumbered without having to experience the negative outcome of being turned away because of carrying restricted items.

In regard to the LOKnCHARGE units, it was determined – based on future needs of the end-user – to place the KL1000 NetCode® on all LOKnCHARGE lockers. The KL1000 NetCode® is a smart way to generate time-sensitive codes for a wide range of lockers.

Codelocks worked with LOKnCHARGE to develop an online portal where anyone can book and pay for a locker in advance. Through Codelocks' NetCode®, a six-digit code can be obtained by a future user with a specific start date, time and duration, resulting in an easy and self-sufficient solution. Once the duration expires, the codes no longer work, creating a more convenient way to grant access. These generated codes can be sent by email or standard text messages.

In addition, a Wi-Fi connection is not required to operate these locks.

"By adding the KL1000 NetCode® to our LOKnCHARGE units, and the partnership with Codelocks, it has helped avoid the risk of loss or theft of important personal items, while providing convenient online booking for our customers," said Benoit. "The LOKnCHARGE solution was presented to Ryan to solve their storage needs."

GAME TIME

Before the season started, Briere and Codelocks representatives traveled to Jacksonville to train the Jaguars guest services team on how to operate the lockers. They were also on-hand during the first three home games to ensure a seamless transition.

Attendees who needed to secure their restricted belongings would simply arrive at the container, access the website (www.jaxlockers.com) through a mobile phone and rent their locker in less than two minutes. For those who didn't have access to a mobile phone or simply rather not use their phone, iPads were available through the stadium support staff for easy access and purchasing. Once that was completed, a six-digit code was sent via text message and email to the user and they would instantly have access to a specific locker. "We went from an extensive check-in process with long lines and using 12 or more employees working long hours, to only needing five or six employees to complete the process," said Prep.

THE FINAL SCORE

LOKnCHARGE was used during 12 stadium events throughout the season, with seven regular season home games, plus two preseason games.

"I'm thrilled the LOKnCHARGE solution was able to be successful for the Jacksonville Jaguars 2019-2020 season," said Briere. "The collaboration between Codelocks and us resulted in a solution that can be used for a variety of events, including our highly attended NFL football games.

"We look forward to working with Codelocks and LOKnCHARGE in the future. It ended up being a great partnership and they took care of all of our needs, questions and feedback to develop a solution that worked for us and, most importantly, our fans," said Prep.



[Read the full case study online.](#)



K3 Connect: Setting Up

1. Install the K3 Connect App on your device.
2. Once installed, open K3 Connect and log in.
3. The account creation process includes:
 - Click the account has been created.
 - To add a new lock, click the + icon on the top right.
4. Enter the lock IDN and choose a lock ID.
 - Note: The lock IDN is case-sensitive.
 - Example: 123456789 - 101
5. In the App, click the + icon and then click:
 - Master Code - (0) - 1 -
 - Default - #123456789 - 101 -
7. The lock will now pair with your phone.

training + support

Codelocks fully dedicated website offers technical information and support including programming and installation. Watch handy videos on how to fit and perform code changes, read our latest case studies, find out what events we will be attending worldwide, sign up to our newsletter and read our helpful blog. Spare parts and accessories for locks are also available to purchase online.

Simply visit www.codelocks.com     

Aftercare

No maintenance of the working parts is necessary. Do not oil. To maintain the finish the lock should be cleaned regularly with a soft cloth. A silicon spray or similar should be used to provide a protective film against grit and grime. It is strongly recommended to undertake a regular maintenance schedule and wipe the outer surface of all Codelocks products clean and encourage the displacement of water. Do not use oil-based lubricants as these will attract dirt.

Training

Codelocks introduced locksmith training courses in 2012. We wanted to work with the people installing and servicing our coded locks on a daily basis. The locksmiths that attend our courses provide us with valuable feedback, allowing us to make further improvements to our product line. In return, we offer the opportunity to refresh their technical knowledge and gain free access to expert tuition. Whether you are a locksmith new to the trade, or part of a well-established Estate & Facilities Management team we can provide a personalised training programme to suit your needs. Please contact Codelocks or visit the website to learn more about this service.

Service

Most issues relating to Codelocks products can be resolved quickly with our Customer Services team. We offer a full repairs service for all our products. Products still in warranty will be repaired free of charge*. For products out of warranty or where repair is required due to misuse, abuse or poor fitting, there is a small charge plus costs for any parts required. Either call or email us and we can help you get your lock back up and running.

Guarantee

Codelocks mechanical locks offer a limited lifetime guarantee; any of our mechanical locks will be repaired, serviced or replaced free of charge if they develop a manufacturing fault. Codelocks electronic locks offer a two year guarantee*.

*Faults caused by misuse, abuse and/or poor fitting are not covered by the guarantees.

Disclaimer for using Codelocks mechanical or electronic digital locks with existing lock cases. When using Codelocks front and back plates only, please test with your lock case to ensure that the latch retracts fully from the code side without too much resistance. Some lock cases have a heavily sprung latch follower for use with unsprung lever furniture. This heavy springing may damage the clutch on our locks. If in doubt do not specify one of our locks with a lock case that is designed for use with unsprung levers. Also ensure that the code on the mechanical locks re-sets or clears. The code chamber requires that the lever is rotates 45 degrees to reset the lock for the next code user. Please contact Codelocks technical support team for further advice. Codelocks does not accept responsibility for products incorrectly specified. Please note that all the product dimensions in this brochure are nominal and subject to tolerances. Whilst every effort has been made to ensure the contents of this publication are accurate, no liability will be accepted by Codelocks (LTD, INC, PTY) for any errors or omissions.



If you would like to know more about Codelocks and how you can benefit from the control and convenience the locks provide, contact one of our international offices.

**CODELOCKS UK
HEADQUARTERS**

Tel: +44 (0) 1635 239645
Fax: +44 (0) 1635 239644
sales@codelocks.com
www.codelocks.com

Helpline, service & spares
Freephone: 0800 393 405

**CODELOCKS INC
(UNITED STATES)**

Tel: +1 714 979 2900
Fax: +1 714 979 2902
sales@codelocks.us
www.codelocks.us

Helpline, service & spares
Toll free: 1.877.codelock

**CODELOCKS PTY LTD
(AUSTRALIA)**

Tel: +61 2 9882 1009
Fax: +61 2 9882 6030
sales@codelocks.com.au
www.codelocks.com.au

Helpline, service & spares
Toll free: 1800 052 131

**CODELOCKS EU B.V.
EUROPE**

Tel: +31 53 80 80 118
sales@codelocks.eu
www.codelocks.eu



CODELOCKS

control + convenience

www.codelocks.com